

IP AUDIO SERIES

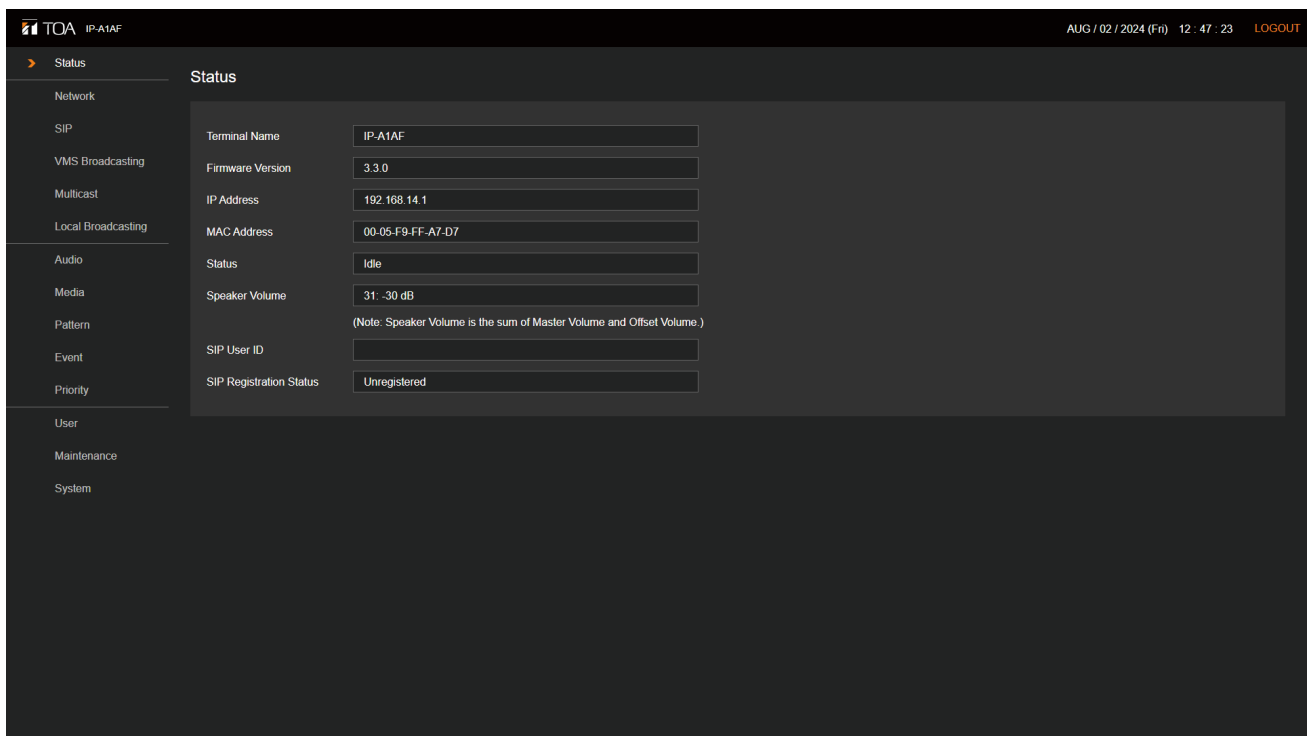

This manual provides the following explanations:

- Setup and operation of the IP-A1 Device using a web browser.
- Setting up the Device's detection and network settings using the IP Setting Tool.

For instructions on installation, please refer to the Instruction Manual supplied with the product.

- Devices covered by this manual:
 - IP-A1PC238 IP Ceiling Speaker 8W
 - IP-A1AF IP Audio Interface
 - IP-A1PC580R IP Ceiling Mount Speaker 8W
 - IP-A1PC580S IP Square Speaker 8W
 - IP-A1SC15 IP Horn Speaker 15W
 - IP-A1PA12 IP Power Amplifier 12W

- The explanations in this manual only apply to firmware versions 3.3.0 or later.

Thank you for purchasing TOA's IP Audio Series.

Please carefully follow the instructions in this manual to ensure long, trouble-free use of your equipment.

TABLE OF CONTENTS

1. INTRODUCTION	4
1.1. About This Manual	4
1.2. System Requirements	4
1.3. Security Measures	4
2. HOW TO USE THE BROADCAST FUNCTION	5
2.1. Performing Internal Sound Source Broadcasting	5
2.2. Performing Local Broadcasting	6
2.3. Performing SIP broadcasting	7
2.4. Performing VMS Broadcasting	8
2.5. Performing Multicast Broadcasting	9
3. CONNECTION WITH BROWSER	10
3.1. Connection Presets	10
3.2. Making Connection	10
4. CURRENT DATE AND TIME SETTINGS	11
4.1. Automatic Date and Time Synchronization with the NTP Server	11
4.2. Synchronization with a Connected PC's Clock (Date and Time)	12
4.3. Manual Date and Time Settings	12
5. OPERATIONS COMMON TO EACH SCREEN	13
5.1. Screen Layout	13
5.2. Saving Settings or Changed Contents	14
5.3. Restarting the Device	15
5.4. Logging Out	15
6. SETTINGS	16
6.1. About the Setting Menu Composition of Each Model	16
7. STATUS SCREEN DISPLAY	18
7.1. Status Screen and Status Indicators	20
8. NETWORK SETTINGS SCREEN	21
9. SIP SETTINGS SCREEN	22
10. VMS BROADCASTING SETTINGS SCREEN	24
11. MULTICAST SETTINGS SCREEN	25
12. LOCAL BROADCASTING SETTINGS SCREEN	27
13. AUDIO SETTINGS SCREEN	28
13.1. Conceptual Diagram of the Sound Volume Settings Function	30
14. MEDIA SETTING SCREEN	32
14.1. Uploading Sound Source Files	33
14.2. Downloading Sound Source Files	33
14.3. Deleting Sound Source Files	34
15. PATTERN REGISTRATION SCREEN	35
15.1. Performing Tests of Pattern Broadcast	39
16. EVENT SETTINGS SCREEN	40
17. PRIORITY SETTINGS SCREEN	44

18. USER SETTINGS SCREEN	47
19. MAINTENANCE SCREEN	48
19.1. Downloading Setting File	49
19.2. Uploading Setting File	50
19.3. Initialization of Settings	51
19.4. Factory Default Settings	52
19.5. Firmware Update	53
19.6. Downloading the Log File	54
20. SYSTEM SETTINGS SCREEN	57
21. USABLE CHARACTERS	59
21.1. Characters That Can Be Used for Names, Authentication ID and Passwords	59
21.2. Characters That Can Be Used for Filenames	60
22. IP SETTING TOOL	61
22.1. Before Using:	61
22.2. Starting the IP Setting Tool	61
22.3. Setting Method	62
22.4. User Authentication	64
22.5. Network Settings	64
22.6. Uploading Settings Files	67
22.7. Downloading Settings Files	68
22.8. Firmware Update	69
22.9. Restarting the Device	70
23. TROUBLESHOOTING	71
24. WHAT TO DO WHEN IN TROUBLE	76

1. INTRODUCTION

1.1. About This Manual

This manual covers the following models:

IP-A1PC238	IP Ceiling Speaker 8W
IP-A1AF	IP Audio Interface
IP-A1PC580R	IP Ceiling Mount Speaker 8W
IP-A1PC580S	IP Square Speaker 8W
IP-A1SC15	IP Horn Speaker 15W
IP-A1PA12	IP Power Amplifier 12W

Furthermore, the explanations in this manual only apply to firmware versions 3.3.0 or later.

The display screens used in this manual are mainly related to the IP-A1AF IP Audio Interface. The actual screens may differ slightly depending on the model.

Additionally, some functions and settings may differ depending on the model. In this manual, if a description applies only to a specific model, the following warning will be displayed:

- AF** Applies only to IP-A1AF.
- PC580R/S** Applies only to IP-A1PC580R and IP-A1PC580S.
- PA12** Applies only to IP-A1PA12.

1.2. System Requirements

Recommended PC operational environments are as follows:

Display	Resolution: 1920 x 1080 or greater
OS	Windows 10 Pro (64bit) Windows 10 Home (64bit) Windows 11 Pro Windows 11 Home
Browser	Microsoft Edge Google Chrome

Notes

- Microsoft Edge is the registered trademark of Microsoft Corporation in the United States and other countries.
- Google Chrome is the trademark of Google LLC in the United States and other countries.

1.3. Security Measures

- Ensure that sufficient security measures are taken on the customer's own responsibility.
- TOA Corporation takes no responsibility for damage or loss caused by security-related problems, such as illegal access.
- To help prevent illegal access to the device, be sure to change the user ID and password from those used for initial setup. For setting methods and other details, please refer to the User Settings Screen on [p. 47](#).
- Take utmost care in the management of the device's communications password.

2. HOW TO USE THE BROADCAST FUNCTION

This section describes the Broadcast Settings procedure. To carry out setup, please refer to the following procedure:

2.1. Performing Internal Sound Source Broadcasting

To perform broadcasting from the files stored in the device's Internal sound source, please refer to the following setup procedure.

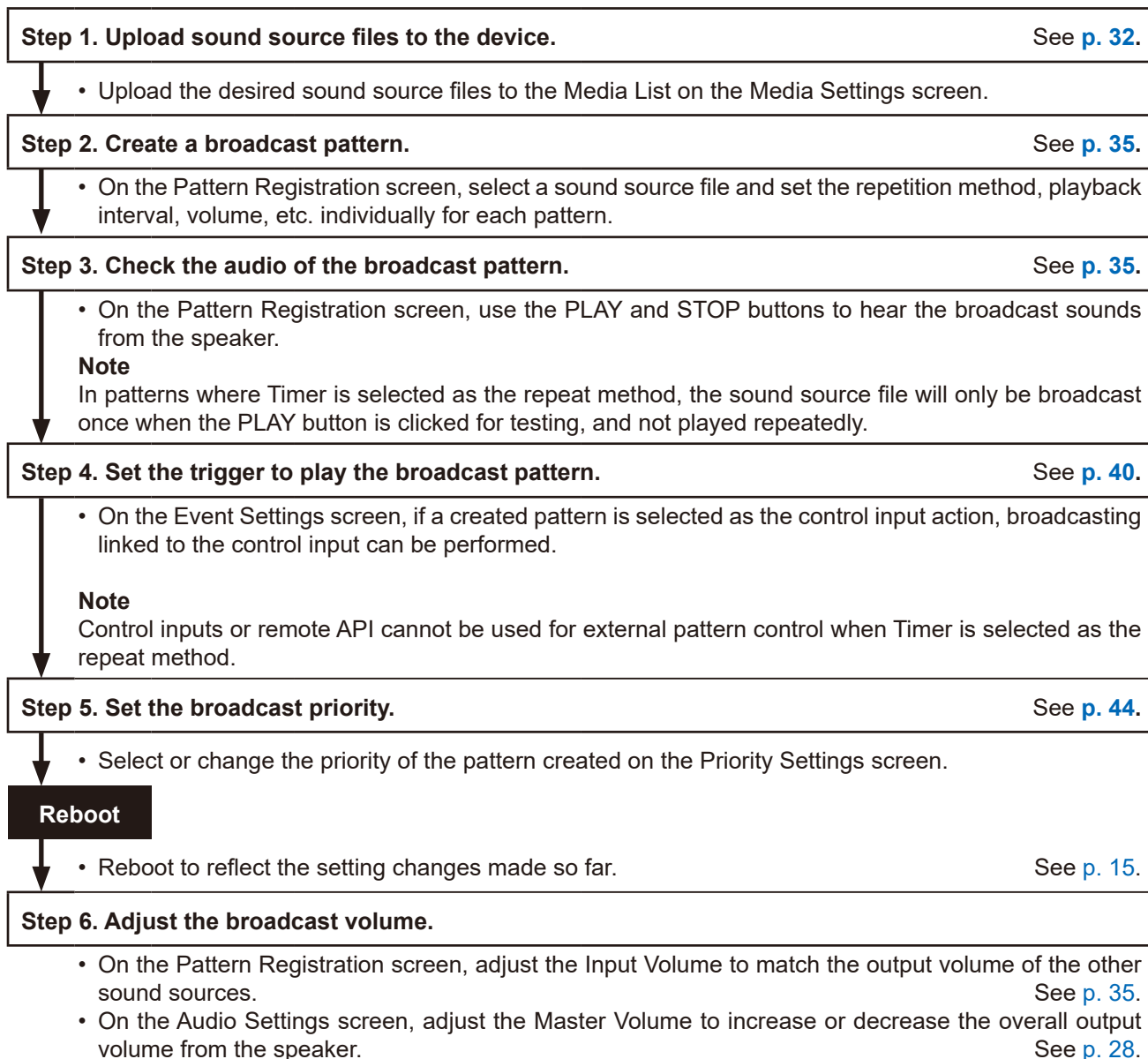

2.2. Performing Local Broadcasting

AF

PA12

To perform Local Broadcasting from an external sound source device connected to the device, please refer to the following setup procedure:

Step 1. Enable the Local Broadcasting function.

See [p. 27](#).

- Turn ON Local Broadcasting Function on the Local Broadcasting Settings screen.

Step 2. Select the Mode.

See [p. 27](#).

- The broadcast mode can be selected depending on Local Broadcasting usage.
- To broadcast with no delays between input and output, such as microphone broadcasts in the same space, select No Delay in the Mode settings.
- To adjust the input volume during broadcasts, select Normal in the Mode settings.

Step 3. Set a trigger to enable local broadcasting.

See [p. 40](#).

- On the Event Settings screen, if Local Broadcasting is selected as the control input action, Local Broadcasting linked to the control input can be performed.

Step 4. Set the broadcast priority.

See [p. 44](#).

- Select or change the Local Broadcasting priority on the Priority Settings screen.

Reboot

- Reboot to reflect the setting changes made so far.

See [p. 15](#).

Step 5. Adjust the broadcast volume.

See [p. 27](#), [p. 28](#).

- On the Local Broadcasting Settings screen, adjust the Input volume to match the output volume of the other sound sources.
- On the Audio Settings screen, adjust the Master Volume to increase or decrease the overall output volume from the speaker.

Note

If the selected Mode is No Delay, the Input volume settings on the Local Broadcasting Settings screen will be disabled.

2.3. Performing SIP broadcasting

SIP Broadcasting can be enabled by calling the device from a SIP phone or SIP intercom. Please refer to the following setup procedure:

2.3.1. When performing SIP broadcasting via a SIP server

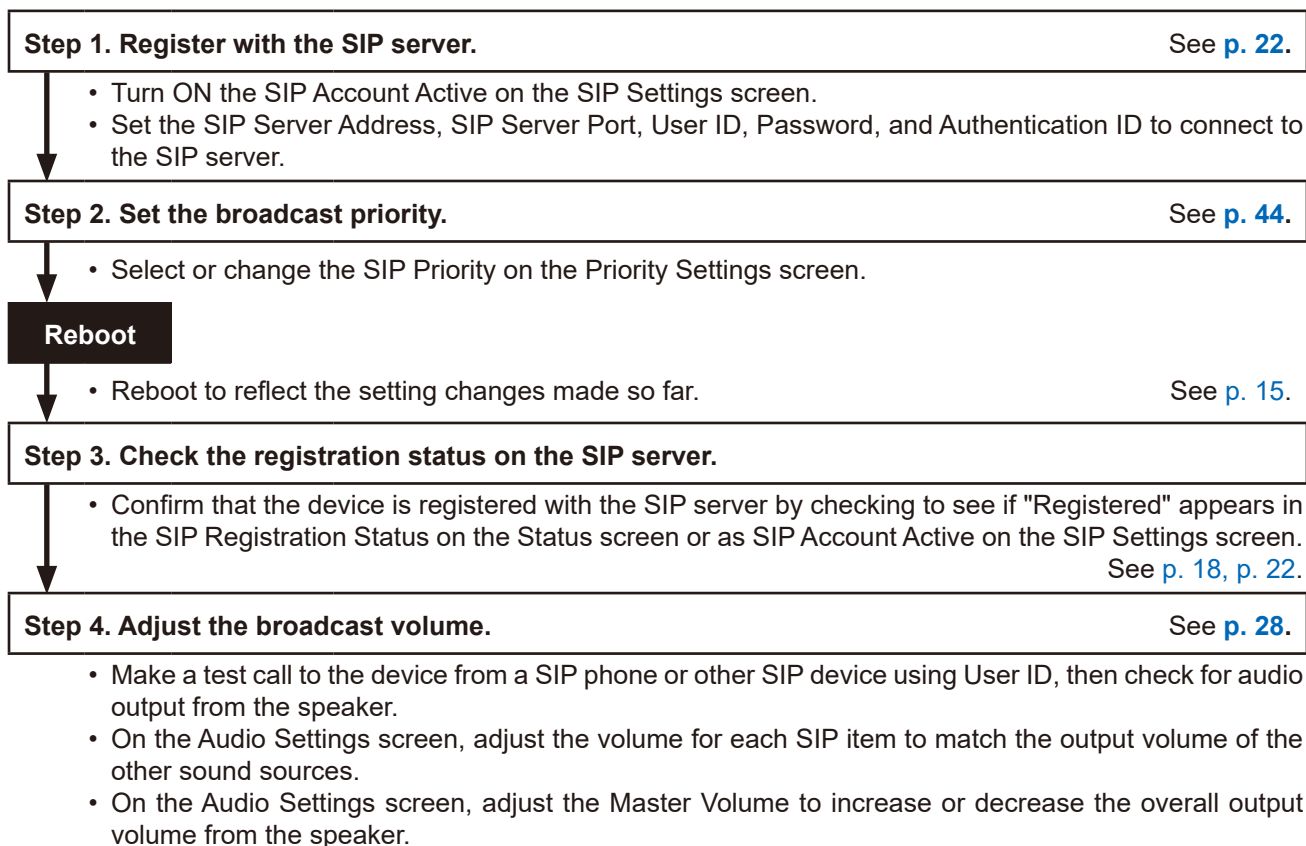

2.3.2. P2P SIP Broadcasting

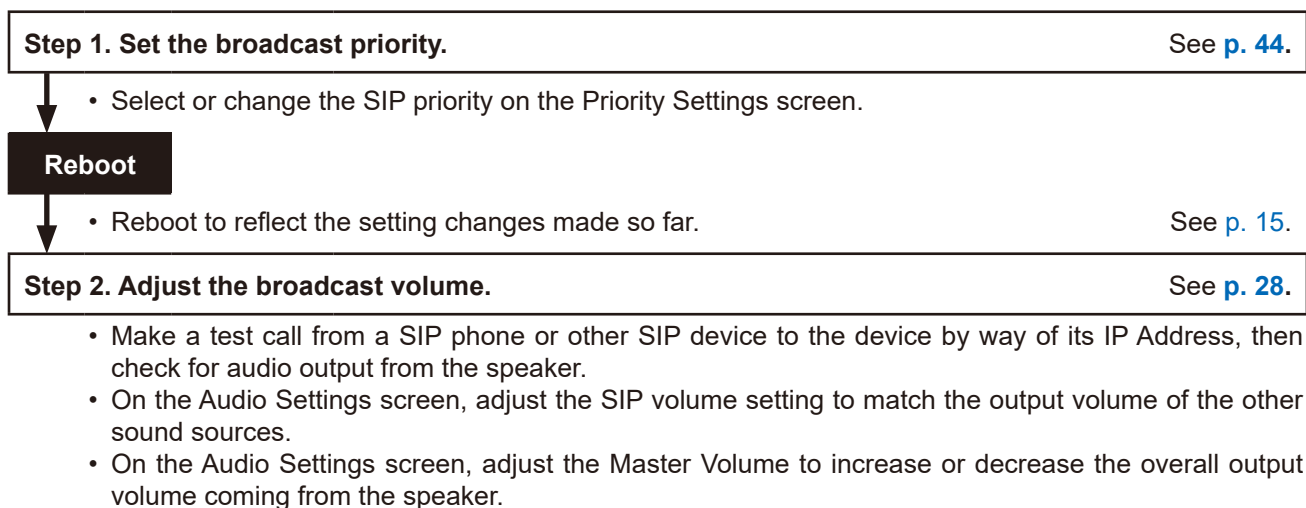

2.4. Performing VMS Broadcasting

By registering the device with or connecting it to a network recorder (NVR) or Video Management System (VMS), VMS broadcasting can be performed using the microphones connected to these clients. For VMS Broadcast Settings, please refer to the following setup procedure:

Step 1. Enable detection, registration & connection of the device using the ONVIF protocol.

See [p. 24](#).

- Turn ON the VMS Connection on the VMS Broadcasting Settings screen.
- Set the Control Port, RTSP Port, Username and Password to allow detection by or registration with the NVR or VMS clients.

Step 2. Set the broadcast priority.

See [p. 44](#).

- Select or change the VMS Broadcasting priority on the Priority Settings screen.

Reboot

- Reboot to reflect the setting changes made so far.

See [p. 15](#).

Step 3. Register the device with or connect it to NVR or VMS as an ONVIF device.

- Refer to the NVR or VMS instruction manual for more details on detecting, registering or connecting the ONVIF device.

Step 4. Adjust the broadcast volume.

See [p. 28](#).

- Operate the NVR or VMS client and check that the microphone can be used for broadcasting.
- On the Audio Settings screen, adjust the VMS Broadcasting volume to match the output volume of the other sound sources.
- On the Audio Settings screen, adjust the Master Volume setting to increase or decrease the overall output volume from the speaker.

Note: ONVIF is the trademark of ONVIF Inc.

2.5. Performing Multicast Broadcasting

In order to receive a multicast audio stream for Multicast Broadcasting, please refer to the following setup procedure:

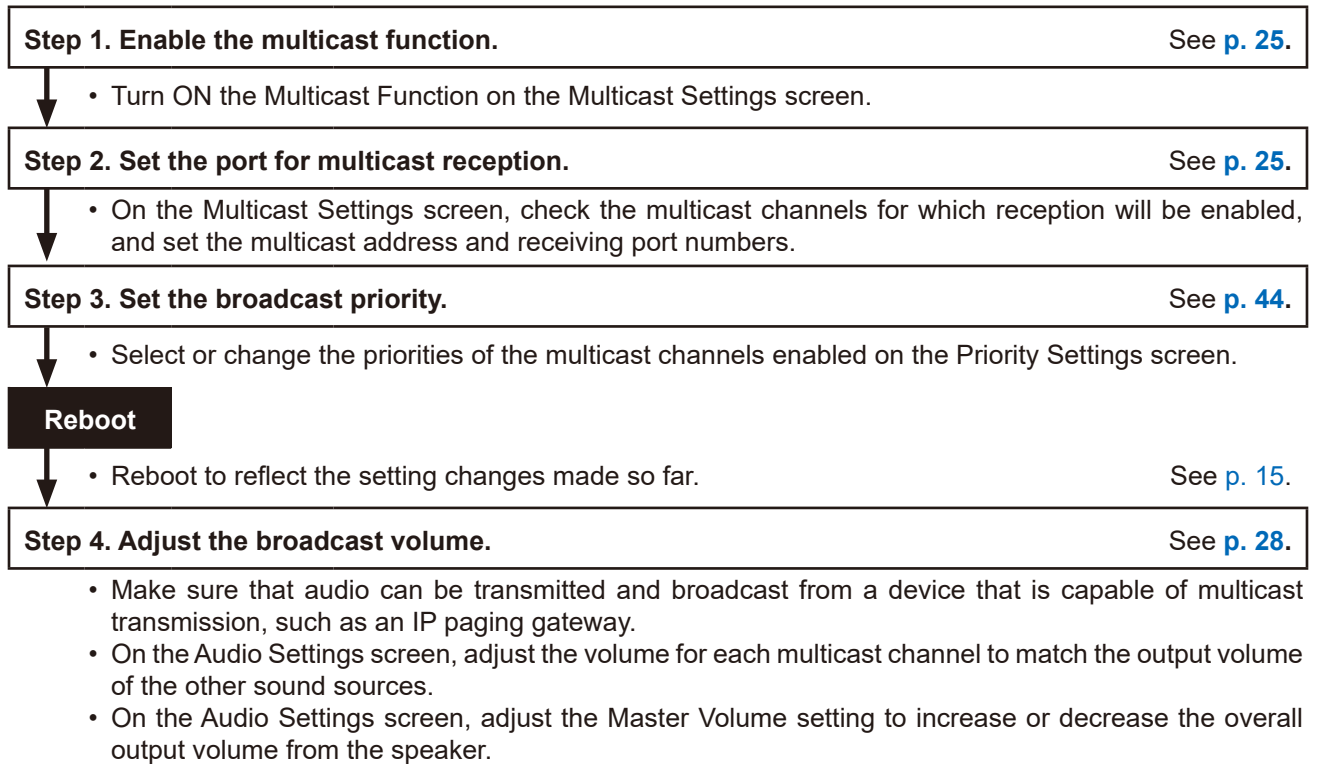

3. CONNECTION WITH BROWSER

3.1. Connection Presets

The device is factory-preset as follows:

Username: admin
Password: guest
IP address: 192.168.14.1
Subnet mask: 255.255.255.0
Default gateway: 0.0.0.0

Before connecting a PC to the device and changing its setting, it will be necessary to set the PC's network settings so that it can operate on the same network as the device. Take care that no IP addresses are duplicated in the same network. For example, if the device's IP address is 192.168.14.1, set the PC's IP address to 192.168.14.10 or the like.

3.2. Making Connection

Notes

- Avoid simultaneously connecting to the device from multiple PCs.
- Avoid simultaneously connecting to the device from a single PC using multiple browsers.

Step 1. Connect both the device and the PC to be used for setup to the network.

Step 2. Start the PC's browser and enter the device's IP address in the address field.

Example: 192.168.14.1

The Login screen will be displayed.

Tip

Default IP address: 192.168.14.1

Step 3. Enter both the username and the password, and click on the LOGIN button.

The Status screen will be displayed.

Click on the individual function names arranged on the left side of the browser screen to switch screens and perform the required settings for each selected screen.

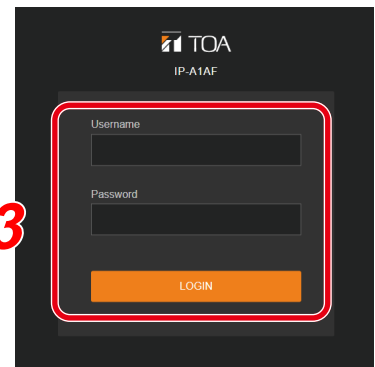

3

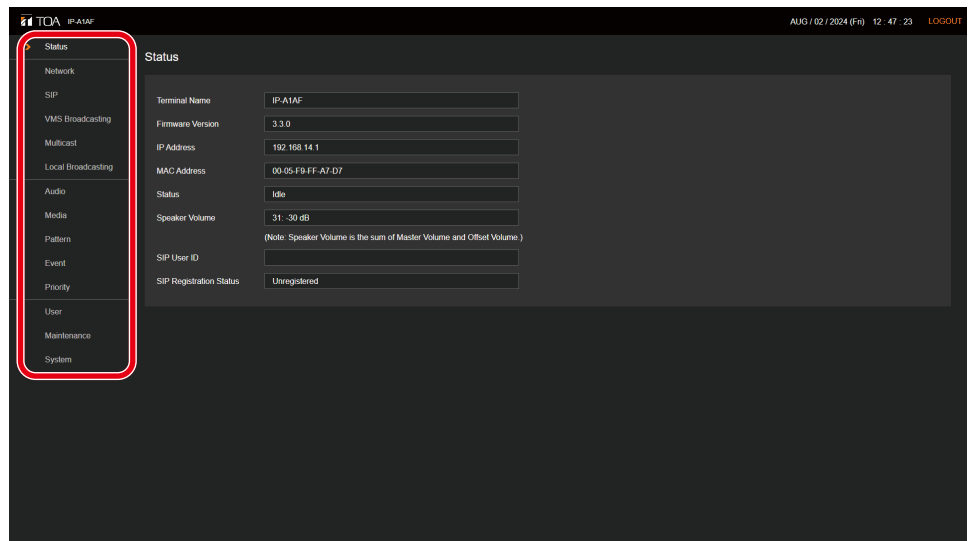

4. CURRENT DATE AND TIME SETTINGS

Before beginning to use the device, be sure that the current date and time are correctly set. This initial setting is required in order to accurately set and operate the device's Timer function or confirm its logs. First go to the System settings screen to perform these settings (p. 57).

Note

When the device is used for the first time or has not been powered for long periods of time, the message below is displayed.

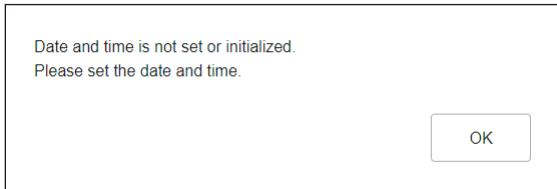

In such cases, set the current date and time using one of the following procedures

4.1. Automatic Date and Time Synchronization with the NTP Server

Step 1. Switch ON NTP and designate the NTP server to be used to synchronize the date and time.

Up to two different NTP servers can be set. Enter the IP address or domain for NTP Servers 1 and 2. NTP Server 1 takes precedence and will be synchronized first.

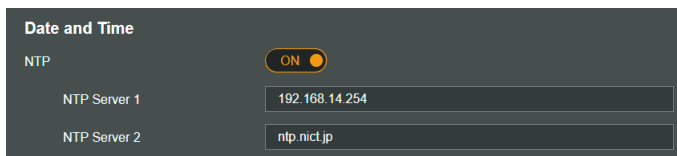

Step 2. Select the Time Zone.

Select the Time Zone of the location where the device is installed.

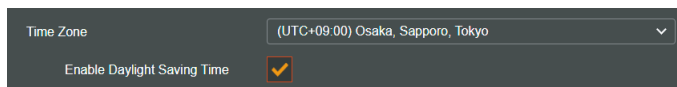

Step 3. Click on the SAVE button.

Any changes to the settings are saved while the date and time are simultaneously synchronized with the NTP server. If synchronization is successful, the indication "Synchronized" is displayed.

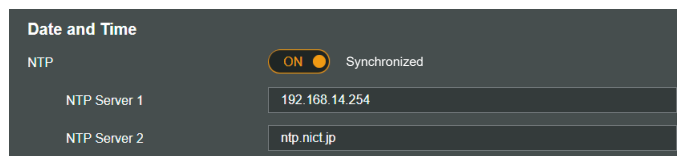

Tips

- This device can be synchronized with an NTP server when NTP is switched ON and...
 - The SAVE button is clicked.
 - The device is restarted.
 - The device's clock is synchronized everyday at 00:01.
- However, no synchronization is possible if the receiving device is currently broadcasting.
- If a broadcast is in progress when the SAVE button is clicked, the reflection of clock setting is given priority and the currently in-progress broadcast is terminated.

4.2. Synchronization with a Connected PC's Clock (Date and Time)

Step 1. Switch ON Sync with PC.

Settings can be changed when the NTP function is switched OFF.



Step 2. Select the Time Zone.

Select the Time Zone of the location where the device is installed.

Step 3. Click on the SAVE button.

Any changes to the settings are saved while the date and time are simultaneously synchronized with the PC displaying the setting screen. Note that synchronization is only performed once, and not on a regular basis.

Note

If the SAVE button is clicked on while a broadcast is taking place, the time setting will take precedence, causing the current broadcast to stop.

4.3. Manual Date and Time Settings

Step 1. Enter the current date and time in the Manual Setting box.

When both NTP and Sync with PC are set to OFF, the date and time can be entered manually.

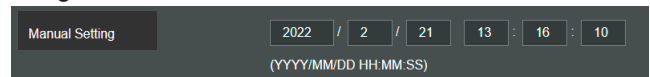

Step 2. Select the Time Zone.

Select the Time Zone of the location where the device is installed.

Step 3. Click on the SAVE button.

The entered date and time are saved.

Note

If the SAVE button is clicked on while a broadcast is taking place, the time setting will take precedence, causing the current broadcast to stop.

5. OPERATIONS COMMON TO EACH SCREEN

5.1. Screen Layout

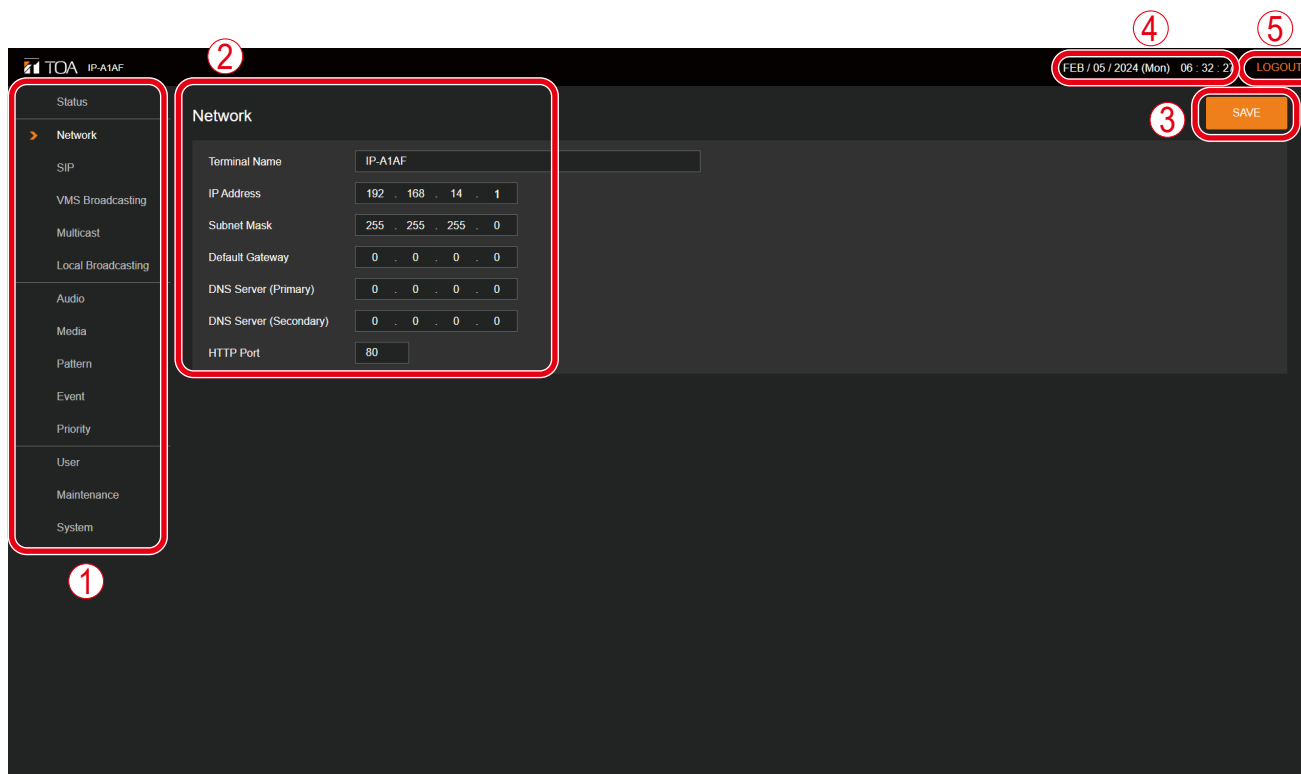

	Name	Description
(1)	Settings Menu	Clicking on the Settings menu automatically switches the screen to the Setting Items window. If a setting item is changed, click on the SAVE button to save the changed contents before switching from the Setting Items window.
(2)	Setting Items Window	Displays the setting items for each Settings menu. If a setting item is changed, click on the SAVE button to save the changed contents before switching from the Setting Items window.
(3)	SAVE button	Saves the changed setting contents.
(4)	Current Time Display	Displays the built-in clock's current time.
(5)	LOGOUT Button	Click this button to log out only after confirming completion of setting contents entry or changes. The Logout screen is displayed after logging out.

5.2. Saving Settings or Changed Contents

If any setting items are changed, these changes need to be saved. Note that there may be cases where settings or changes are applied immediately or only after restarting the device.

5.2.1. Cases in which settings or changes are immediately applied

Step 1. Click on the SAVE button.

The following message appears, notifying the user that the setting or change has been immediately applied:



< Pattern Registration Screen >

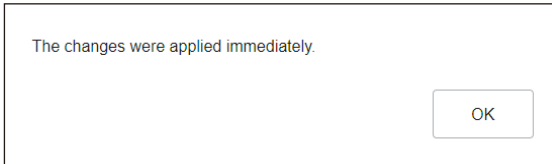

< Audio Settings Screen >

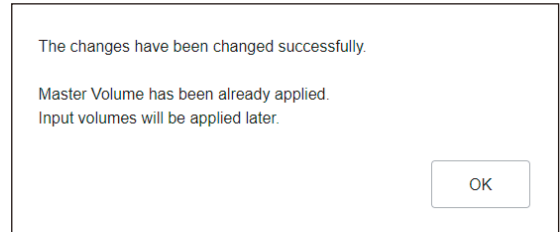

Step 2. Click on the OK button.

5.2.2. Cases in which settings or changes are only applied after device restart

Step 1. Click on the SAVE button.

The message at right appears, notifying the user that the changed contents will only be applied after device restart.



Step 2. Click on the OK button.

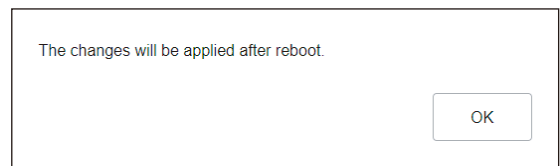

Step 3. Move to the Maintenance screen and click on REBOOT.



Note

Attempting to switch screens without clicking on the SAVE button after changes are made to the settings or contents of each screen (Status screen, Media Settings screen and Maintenance screen excepted) will cause the screen at right to appear:

- If saving changes made to the setting contents of a screen, first click on the NO button, then the SAVE button, before switching screens.
- If not saving changes made to the setting contents, click on the YES button. The display will switch to another screen without saving the contents.

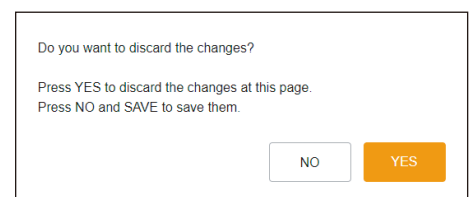

5.3. Restarting the Device

The procedure for restarting (or rebooting) the device is as follows:

Step 1. Move to the Maintenance screen.



Step 2. Click on the REBOOT button.
A confirmation dialog box is displayed.

Step 3. Click on the YES button.
The network connection with the device is disconnected, causing the device to automatically restart.



5.4. Logging Out

LOGOUT button

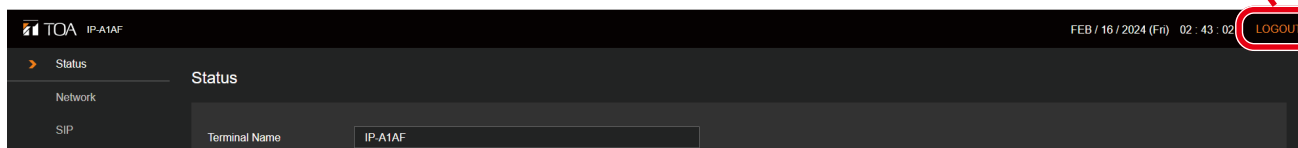

To terminate the network connection after completing confirmation or changes to the device's settings, click on the LOGOUT button.
When logged out, the Login screen will be displayed.

6. SETTINGS

6.1. About the Setting Menu Composition of Each Model

The setting menu to be displayed on the left side of the screen differs depending on the model.

IP-A1PC238, IP-A1SC15,
IP-A1PA12

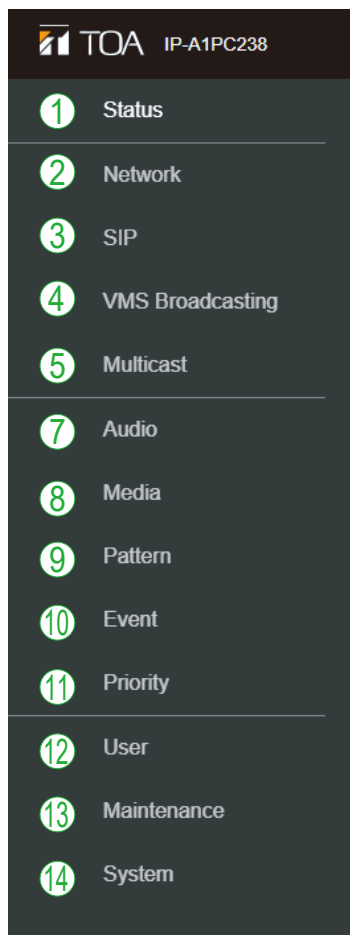

This screen represents the IP-A1PC238.

IP-A1AF, IP-A1PA12

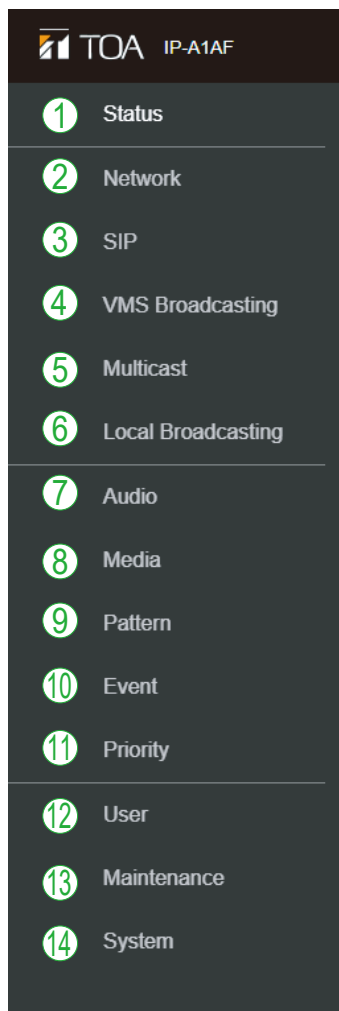

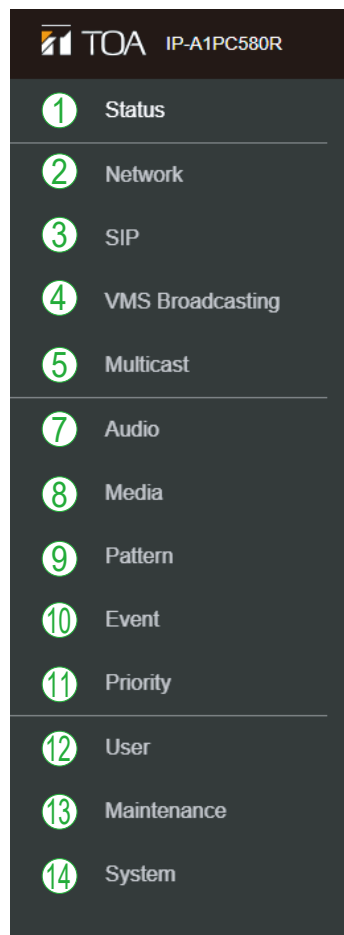

This screen represents the IP-A1AF.

IP-A1PC580R, IP-A1PC580S



This screen represents the IP-A1PC580R.

	Setting Name	Setting Item	Application of setting changes	Page
(1)	Status screen	Confirmation of current firmware version, network settings, volume setting	—	p. 18
(2)	Network Settings screen	Network settings such as the IP address	After restart	p. 21
(3)	SIP Settings screen	Settings of SIP connection enable/disable, SIP server address, authentication information, and audio codec	After restart	p. 22
(4)	VMS Broadcasting Settings screen	Settings of VMS connection enable/disable and authentication information, connection port settings	After restart	p. 24
(5)	Multicast Settings screen	Settings of multicast reception enable/disable, multicast address and port	Immediately	p. 25
		Settings of control output during multicast broadcast	After restart	
(6)	Local Broadcasting Settings screen  	Settings of local broadcasting function enable/disable and broadcasting mode (normal/no delay) Tip When the local broadcasting function is enabled, the audio (SIP call and VMS monitoring audio) from this device to network is muted.	Immediately	p. 27
(7)	Audio Settings screen	Settings of speaker volume, input volume for individual broadcast classifications, and the sensitivity of LINE/MIC input for SIP and VMS broadcasting	Immediately	p. 28
(8)	Media Settings screen	Uploading/downloading or deletion of sound source files such as messages to or from the internal memory	—	p. 32
(9)	Pattern Registration screen	Registration of sound source playback to be associated with events as patterns	Immediately	p. 35
(10)	Event Settings screen	Settings of operations to be synchronized with the control input and control output	After restart	p. 40
(11)	Priority Settings screen	Settings of priority order for each broadcast mode; SIP broadcast, VMS broadcast, multicast broadcast and internal sound source broadcast	After restart	p. 44
(12)	User Settings screen	Changing username and password	Immediately	p. 47
(13)	Maintenance screen	Download and upload the configuration file, initialization, firmware update, hardware reboot, and downloading action logs	—	p. 48
(14)	System Settings screen	Date and time settings, NTP server settings, Time zone settings, language setting	Immediately	p. 57

7. STATUS SCREEN DISPLAY

This screen displays the device's state.

Since this page only displays the current settings, the contents cannot be changed on this page.

TOA IP-A1AF AUG / 02 / 2024 (Fri) 12 : 47 : 23 LOGOUT

> Status

Status

Network

SIP	1 Terminal Name	IP-A1AF
VMS Broadcast	2 Firmware Version	3.3.0
Multicast	3 IP Address	192.168.14.1
Local Broadcast	4 MAC Address	00-05-F9-FF-A7-D7
Audio	5 Status	Idle
Media	7 Speaker Volume	31: -30 dB
Pattern		(Note: Speaker Volume is the sum of Master Volume and Offset Volume.)
Event	8 SIP User ID	
Priority	9 SIP Registration Status	Unregistered

User

Maintenance

System

PA12

TOA IP-A1PA12 FEB / 16 / 2024 (Fri) 02 : 47 : 13 LOGOUT

> Status

Status

Network

SIP	1 Terminal Name	IP-A1PA12
VMS Broadcast	2 Firmware Version	3.3.0
Multicast	3 IP Address	192.168.14.1
Local Broadcast	4 MAC Address	00-05-F9-05-05-05
Audio	5 Status	Idle
Media	6 Speaker Output	Internal Amplifier
Pattern	7 Speaker Volume	31: -30 dB
Event		(Note: Speaker Volume is the sum of Master Volume and Offset Volume.)
Priority	8 SIP User ID	
User	9 SIP Registration Status	Unregistered













Maintenance

System

	Item	Contents
(1)	Terminal Name	Displays the device name set on the Network settings screen (p. 21).
(2)	Firmware Version	Displays the device's current firmware version. (See "Firmware Update" on p. 53.)
(3)	IP Address	Displays the device's IP address set on the Network settings screen (p. 21).
(4)	MAC Address	Displays the device's MAC address.
(5)	Status	<p>Displays the device's operating status.</p> <p>Idle: Standby state</p> <p>SIP Calling: Call to a SIP device in progress</p> <p>SIP: SIP broadcasting in progress</p> <p>VMS Broadcasting: VMS broadcasting in progress</p> <p>Multicast 1 – 20: Multicast broadcasting in progress. (Displays the currently received channel numbers.)</p> <p>Pattern 1 – 20 (sound source filename): Internal sound source broadcasting in progress. (Displays the pattern number and the sound source filename currently being executed.)</p> <p>Local Broadcasting: Local broadcasting in progress.</p> <p>System Mute: System currently being muted (by Mute control enabled by transmitter).</p>
(6)	Speaker Output 	<p>Indicates whether the signal from the unit's internal or external amplifier is being directed to its speaker output.</p> <p>Internal Amplifier: The signal from Internal amplifier is being directed to the speaker output.</p> <p>External Amplifier: The signal from External amplifier is being directed to the speaker output.</p>
(7)	Speaker Volume	Displays the current speaker output volume, which is the sum of the Master Volume and Offset Volume. The Master Volume can be set on the Audio Settings screen.
(8)	SIP User ID	Displays the device's name when registering the device on the SIP server. (See "SIP SETTINGS SCREEN" on p. 22.)
(9)	SIP Registration Status	<p>Displays the device's user ID registered on a SIP server. (See "SIP SETTINGS SCREEN" on p. 22.)</p> <p>Registered: Registration successful.</p> <p>Registration Failed: Registration failed.</p> <p>Registering: Registration in progress.</p> <p>Unregistered: Registration invalid.</p>

7.1. Status Screen and Status Indicators

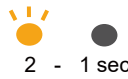
Display of Status items on the Status screen and status indicators (Status LED) have the following relationship:

Device operation	Status display on the Status screen	Status indicator (Status LED)	
		IP-A1PC238 IP-A1SC15 (Orange)	IP-A1AF, IP-A1PC580R/S IP-A1PA12 (Green, Blue, Yellow, Red)
System startup	—	Flashing twice  0.5 - 0.5 - 1 sec	Flashing green  0.5 - 0.5 - 1 sec
Broadcast standby	Idle	Continuously lit 	Continuously lit green 
External amplifier enabled PA12	External Amplifier	—	Broadcast standby: Flashing green  1.5 - 0.5 sec Broadcasting: Flashing blue  1.5 - 0.5 sec
Broadcasting	SIP / SIP Calling VMS Broadcasting Multicast 1 ~ 20 Pattern 1 ~ 20 AF PA12 Local Broadcasting	Continuously lit 	Continuously lit blue 
System mute*	System Mute	Flashing quickly  0.5 - 0.5 sec	Flashing red  0.5 - 0.5 sec
Initialization or firmware updating	—	Flashing slowly  2 - 1 sec	Continuously lit yellow 

* System mute is a state in which this device is muted by the control from the transmitting device, or the control input to the mute terminals of the IP-A1PA12.

8. NETWORK SETTINGS SCREEN

The device's network-related settings are performed on this screen.

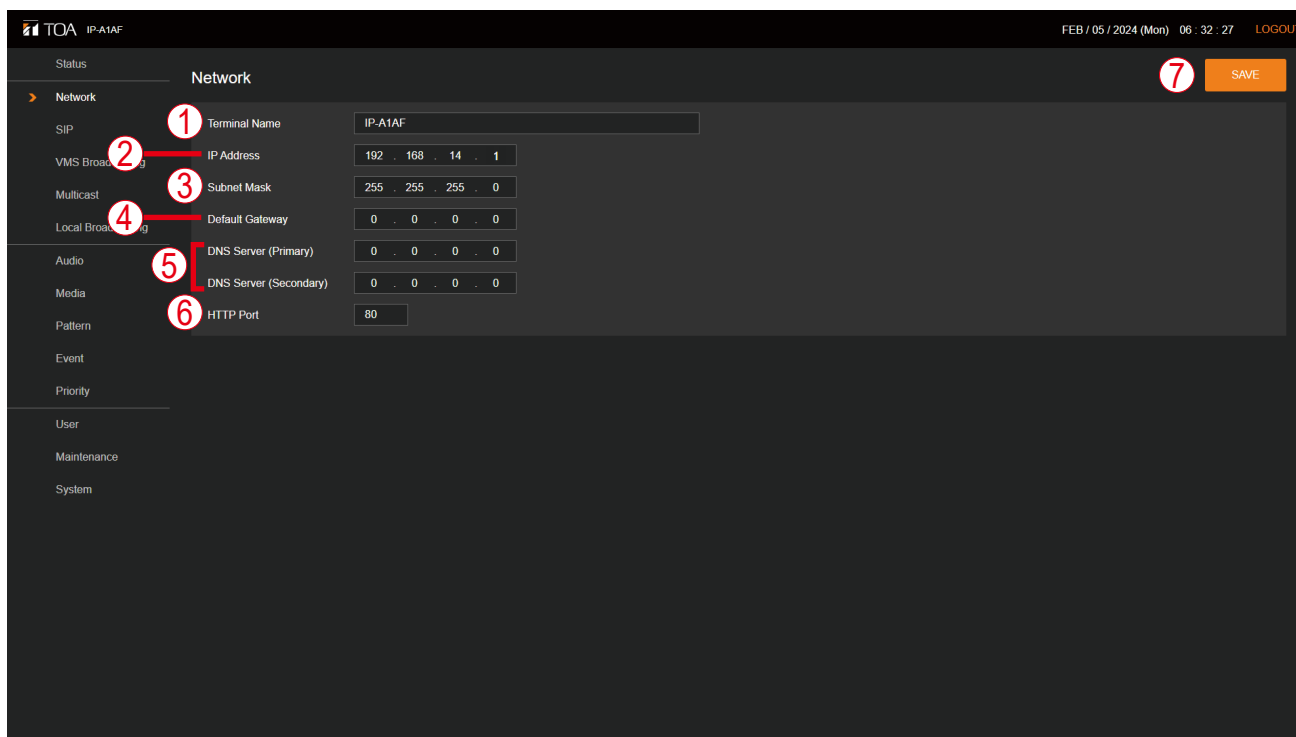

	Item	Contents
(1)	Terminal Name* ¹ , * ²	Set the device's terminal name. Initial setting: (Product Number)
(2)	IP Address* ²	Set the device's IP address. Only private addresses can be entered. Initial setting: 192.168.14.1
(3)	Subnet Mask* ²	Set the device's subnet mask. Initial setting: 255.255.255.0
(4)	Default Gateway* ²	Set the device's default gateway. Initial setting: 0.0.0.0
(5)	DNS Server	Set the primary and secondary DNS server addresses. Initial setting: 0.0.0.0 (Invalid)
(6)	HTTP Port	Set the HTTP server support numbers. Normally, this port is used as found in the initial settings. Setting Range: 80 or 10000 – 40000 Initial setting: 80
(7)	SAVE button	Click to save the settings and changes. (See p. 14.)

*¹ For more information on the characters or number of characters that can be set, please refer to "[USABLE CHARACTERS](#)" on [p. 59.](#)

*² This item's original setting value is retained when the setting file is uploaded.

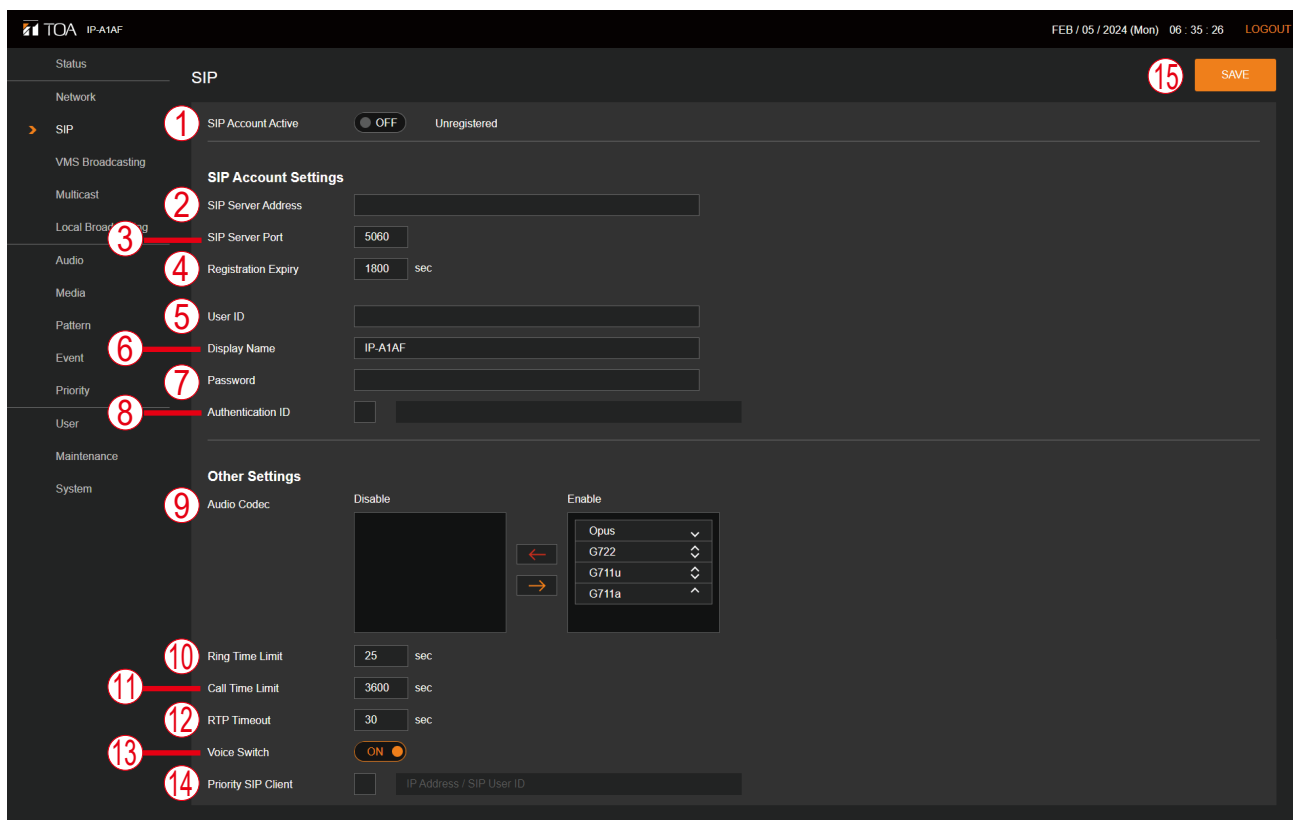

9. SIP SETTINGS SCREEN

Perform all settings related to SIP connections.



Item	Contents
(1) SIP Account Active	Click on the button to enable or disable the SIP account. ON: The SIP account is enabled and registered with the SIP server. OFF: The SIP account is disabled and will not be registered with the SIP server. Initial setting: OFF The registration status with the SIP server is displayed at right. Registered: Registration successful. Registration Failed: Registration failed. Registering: Registration in progress. Unregistered: Registration invalid.
(2) SIP Server Address*	Set the address of the SIP server. The address can be an IP address or a domain name. Initial setting: Blank
(3) SIP Server Port	Set the remote SIP server port number. Setting range: 1024 – 65532 Initial setting: 5060
(4) Registration Expiry	Set the device's SIP server registration expiry period. Set an appropriate value according to the registration authentication expiry preset for the SIP server (unit: sec). Setting range: 60 – 7200 Initial setting: 1800
(5) User ID*	Set the device's SIP account user ID needed when registering the device on the SIP server. Often, this user ID is used when calling up the receiving device. Initial setting: Blank
(6) Display Name*	Set the name of the SIP phone or other SIP devices. The name may be identical to the User ID. Initial setting: Product number

* For more information on the characters or number of characters that can be set, please refer to "USABLE CHARACTERS" on p. 59.

	Item	Contents
(7)	Password*	Set the SIP account password needed to register the device on the SIP server. Initial setting: Blank
(8)	Authentication ID*	Enter the authentication ID needed when registering the device on a SIP server. Place a checkmark in the checkbox when using. Initial settings: Checkbox: Blank Authentication ID: Blank
(9)	Audio Codec	Move the codecs to be used in SIP broadcasts to the Enable frame at right, and unused codecs to the Disable frame at left. Select the desired codec name button (Opus, G722, G711u or G711a) and click on the [←] or [→] button to move the name to the desired frame. When multiple codecs are selected in the Enable frame, the priority of each codec can be set by clicking on the [∨] or [∧] buttons to change their order. (Higher codecs have priority over lower codecs.)
(10)	Ring Time Limit	Set the Max. duration for SIP-connected ringing tones. (Unit: sec.) Setting range: 25 – 60 Initial setting: 25
(11)	Call Time Limit	Set the Max. duration for SIP-connected conversations. (Unit: sec) Setting range: 1 – 18000 Initial setting: 3600
(12)	RTP Timeout	When the device receives no RTP packet during a preset duration, the connection times out and is cut off. Setting Range: 5 – 3600 sec. Initial setting: 30 sec.
(13)	Voice Switch   	When the device is used as a SIP device for conversations, the microphone output can be muted with the Voice switch to prevent acoustic feedback caused by speaker output entering the microphone. ON: The Voice switch is enabled and mutes the microphone while the sound is being output from the speaker. OFF: The Voice switch is disabled, unmuting the microphone. Initial setting: ON
(14)	Priority SIP Client	When a SIP call is received from a device that has been set as a priority broadcast source, the SIP call will supersede any other in-progress SIP calls. Place a checkmark in the checkbox when using. Initial settings: Checkbox: Blank Priority SIP Client: Blank
(15)	SAVE button	Click to save the settings and changes. (See p. 14.)

* For more information on the characters or number of characters that can be set, please refer to "USABLE CHARACTERS" on p. 59.

10. VMS BROADCASTING SETTINGS SCREEN

Perform all settings related to VMS connections.

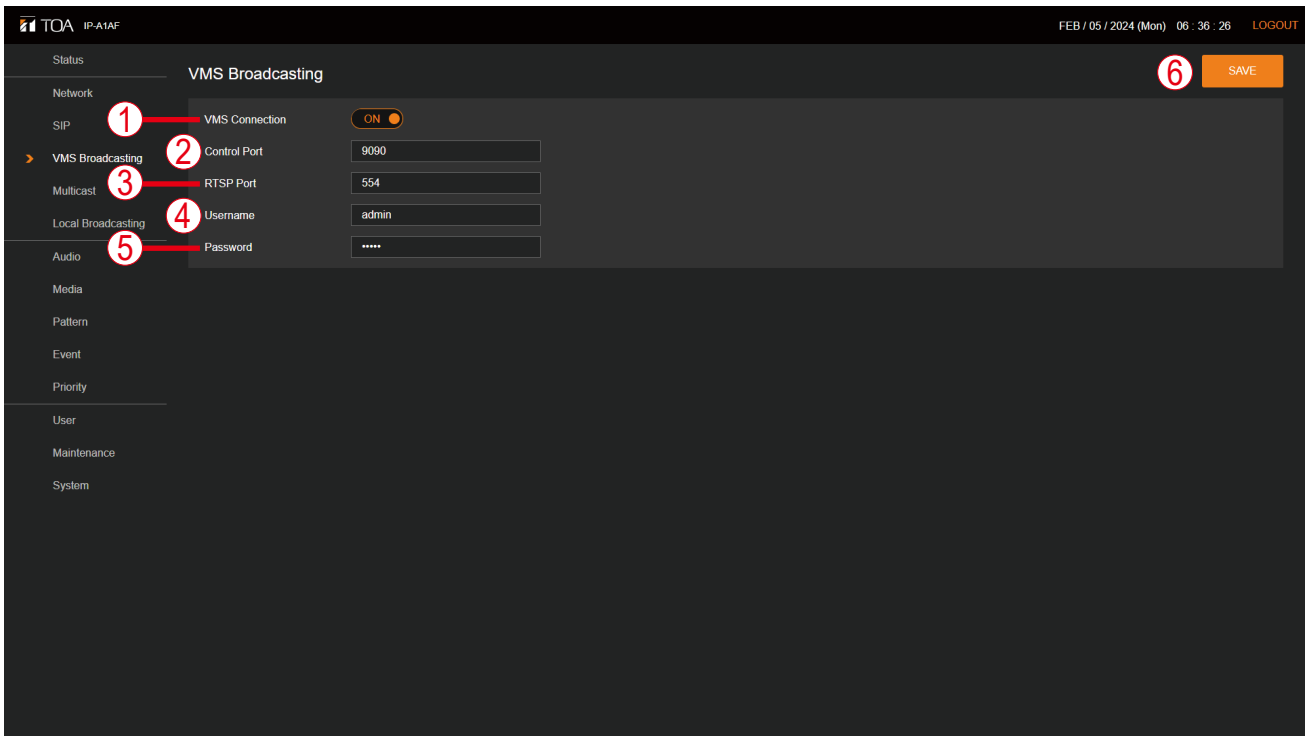

	Item	Contents
(1)	VMS Connection	Click on the switch to select whether or not to use the VMS broadcast function. ON: The Onvif server is enabled, allowing VMS broadcasting. OFF: The Onvif server is disabled, rendering VMS broadcasting inoperable. Initial setting: ON
(2)	Control Port	Set the control port of the device to which VMS software connects. Setting range: 9090 or 10000 – 40000 Initial setting: 9090
(3)	RTSP Port	Set the RTSP port for streaming video from this device to VMS client. Tip If you want to set the port forwarding on the router, set the same port number on the LAN side and WAN side. Setting range: 554 or 10000 – 40000 Initial setting: 554
(4)	Username*	Enter the device's VMS username, which will be needed for other equipment to make a VMS connection to the device. Initial setting: admin
(5)	Password*	Set the password needed for other equipment to make a VMS connection to the device. Default: guest
(6)	SAVE button	Click to save the settings and changes. (See p. 14.)

* For more information on the characters or number of characters that can be set, please refer to "[USABLE CHARACTERS](#)" on [p. 59](#).

Note

When performing VMS broadcasting from VMS software in a WAN environment, the VMS software must support RTP/RTSP/TCP (Video/Audio/Audio Backchannel).

Please check the manual of the VMS software.

11. MULTICAST SETTINGS SCREEN

The Multicast-related settings are performed on this screen.

Tip

The audio codec is automatically recognized. Compatible audio codecs are Opus, PCMU(G.711u), PCMA(G.711a), and G.722.

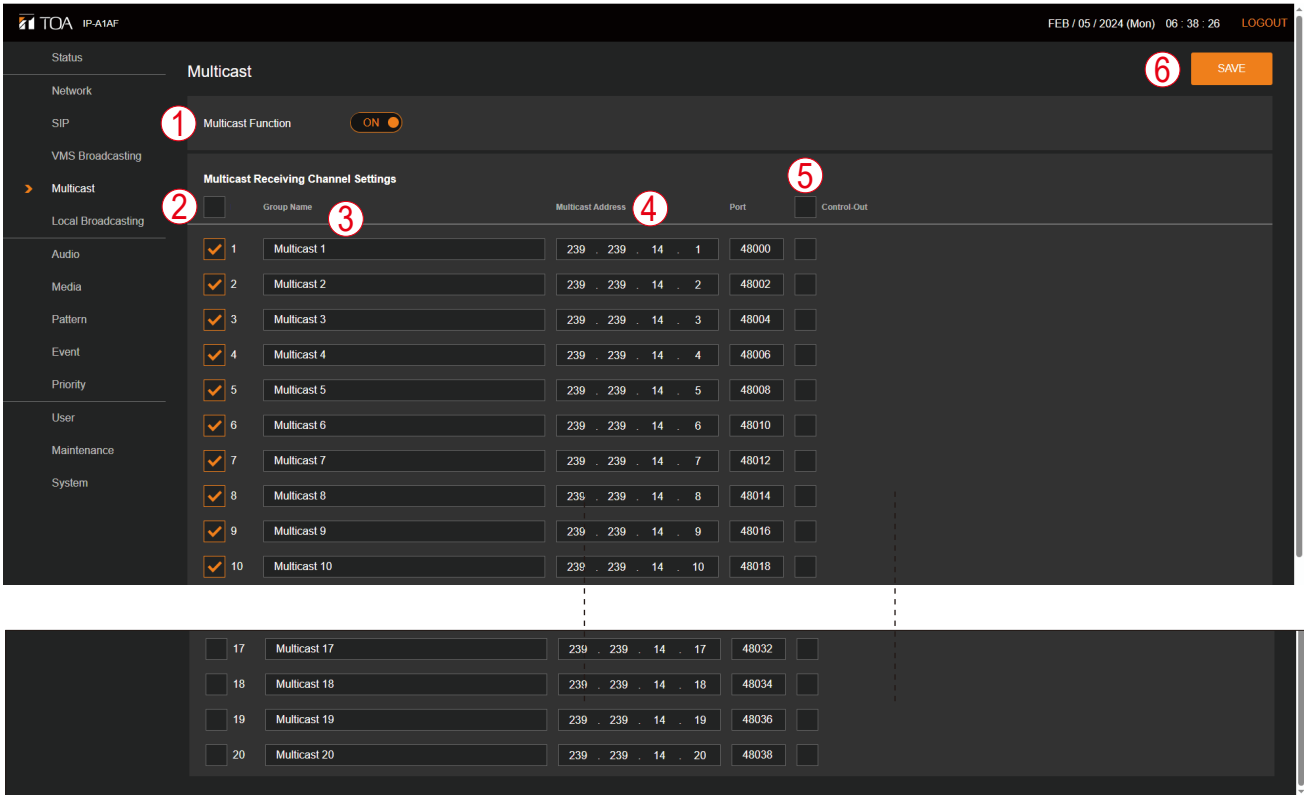

Item	Contents
(1) Multicast Function	Click on the switch to select whether or not to use the multicast broadcast reception function. ON: The Multicast reception function is enabled, allowing Multicast broadcasting. OFF: The Multicast reception function is disabled, rendering Multicast broadcasting inoperable. Initial setting: ON
(2) Multicast Receiving Channel Enable	If a box is checked, the corresponding Multicast receiving channel is enabled, allowing Multicast broadcasting to be performed using the selected channel(s). Initial setting: 1 – 10 checked, 11 – 20 unchecked
(3) Group Name*	Multicast receiving channels can be individually named. Also, broadcasting groups can be created by assigning the names of multiple receiving devices to that of a transmitting device. Initial setting: Multicast 1 – Multicast 20
(4) Multicast Address/Port	Set the receiving address and port number to authorize reception of Multicast audio. Enter the Class D address for the Multicast address. Enter even numbers for the port number. <Multicast address> Setting Range: Class D address Initial setting: 239.239.14.1 – 2329.239.14.20 <Port number> Setting Range: 1024 – 65532 Initial setting: 48000 – 48038 (even numbers only)

* For more information on the characters or number of characters that can be set, please refer to "USABLE CHARACTERS" on p. 59.

	Item	Contents
(5)	Control-out	If a box is checked, external control output will turn on when the unit starts a multicast broadcast on each channel, and turn off again when multicast broadcasting is stopped (multiple selections possible). Initial setting: unchecked
(6)	SAVE button	Click to save the settings and changes. (See p. 14.)

12. LOCAL BROADCASTING SETTINGS SCREEN

AF

PA12

The Local Broadcasting function can be used.

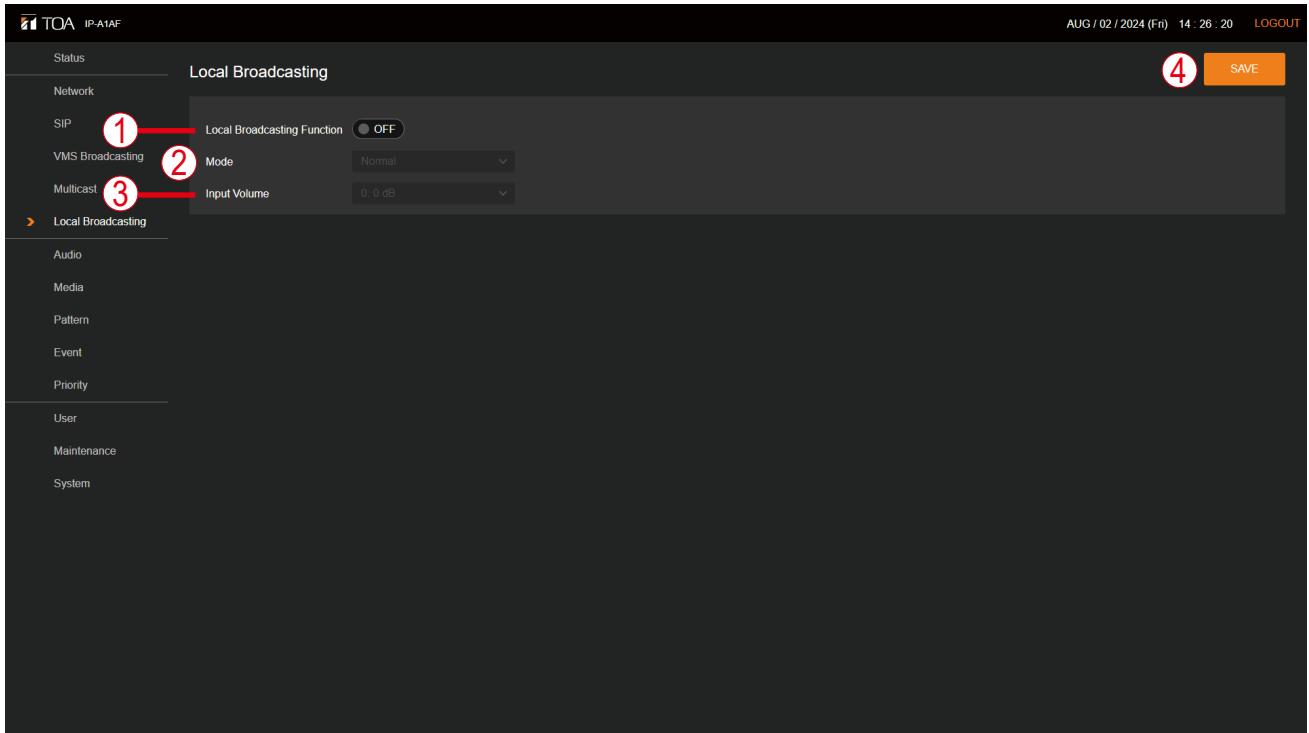

[When Normal is selected in the Mode setting]

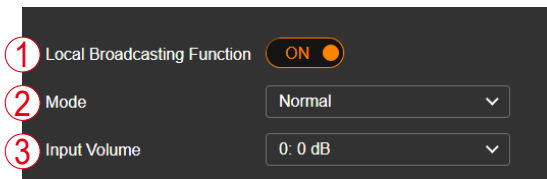

[When No Delay is selected in the Mode setting]

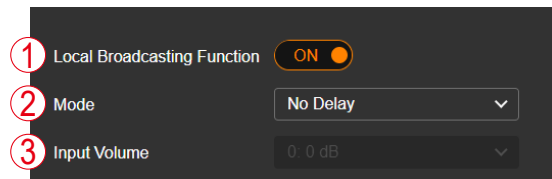

	Item	Contents
(1)	Local Broadcasting Function	Switching this button ON enables Local broadcasting. The audio received at LINE/MIC IN is sent to both the speaker output and LINE OUT. Any changes to the Local broadcasting function are reflected when broadcasting begins again after the SAVE button has been clicked. Initial setting: OFF
(2)	Mode	Select the Mode of Local Broadcasting from the following two options. Any changes to the Mode are reflected when broadcasting begins again after the SAVE button has been clicked. Normal: Audio input from the LINE/MIC IN can be output through the speaker and LINE OUT after changing to the volume set in Input volume (3). No Delay: Audio input from the LINE/MIC IN can be output through the speaker and LINE OUT without any delay. Initial setting: Normal Note Input volume (3) settings cannot be changed when No Delay is selected.
(3)	Input Volume	Click on the [∨] button, then select the desired Local Broadcasting Offset volume from the pull-down menu. Any changes to the Input volume are reflected when broadcasting begins again after the SAVE button has been clicked. Setting range: -20 to +20 dB Initial setting: 0 dB
(4)	SAVE button	Click to save the settings and changes. (See p. 14.)

13. AUDIO SETTINGS SCREEN

The speaker's master volume and correction volume are set for each broadcast using this screen.

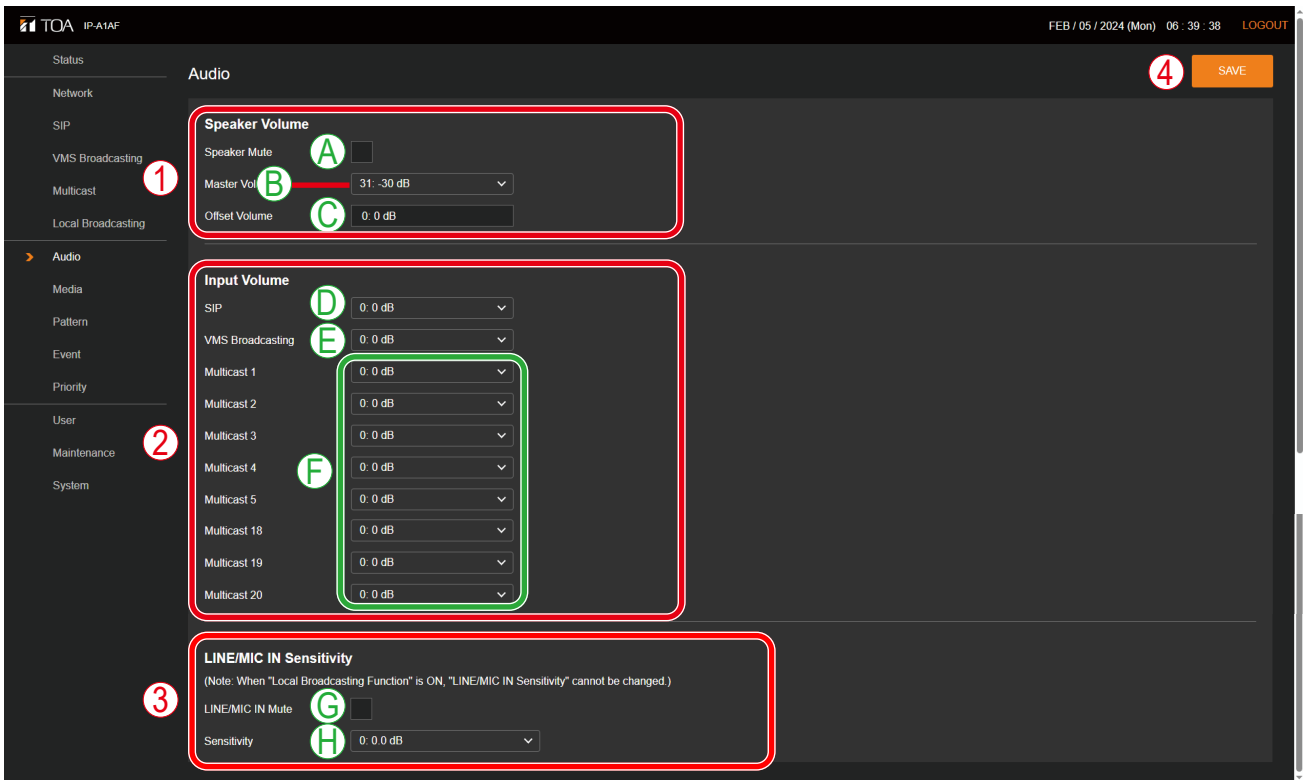

(1) Speaker Volume

Adjust the speaker's broadcasting volume.

	Item	Contents
A	Speaker Mute	<p>Mark the checkbox to mute speaker sound output. Uncheck the checkbox to unmute. Speaker mute or unmute is reflected immediately after the SAVE button is clicked. Initial setting: Unchecked (Unmute)</p> <p>Tip Checking the box mutes the LINE OUT audio as well.</p>
B	Master Volume*	<p>Set the Master Volume as the reference audio volume to be output from the speaker. Set the appropriate audio volume by selecting it from the pull-down menu. Any changes to the Master Volume are reflected immediately after the SAVE button is clicked. Setting Range: 0 (Mute) – 61 (0 dB) Initial setting: 31 (-30 dB)</p>
C	Offset Volume*	<p>Displays the set value of offset volume correction to the Master Volume. The Offset Volume is a function that corrects the audio volume when a control signal is received, either from external equipment or remote API. Display Range: -20 to +20 dB</p>

* Actual speaker broadcasting volume is determined by the sum of the Master Volume and Offset Volume settings.

(2) Input Volume

Set the correction volume for each broadcast.

	Item	Contents
D	SIP Broadcasting Volume (SIP)	Click on the [✓] mark and select the desired correction volume for SIP broadcasts from the pull-down menu. The SIP broadcast volume is reflected immediately after the SAVE button is clicked. Setting range: -20 to +20 dB Initial setting: 0 dB
E	VMS Broadcasting Volume (VMS Broadcasting)	Click on the [✓] mark and select the desired correction volume for VMS broadcasts from the pull-down menu. Any changes to the VMS broadcast volume are reflected when broadcasting begins again after the SAVE button has been clicked. Changes made during VMS broadcasting are not reflected while the broadcast is in progress. Setting range: -20 to +20 dB Initial setting: 0 dB
F	Multicast Broadcasting Volume (Multicast 1 – 20)	Click on the [✓] mark and select the desired correction volume for Multicast broadcasts from the pull-down menu. Changes in the Multicast broadcast volume are reflected approximately 3 seconds after the SAVE button has been clicked. Setting range: -20 to +20 dB Initial setting: 0 dB

(3) LINE/MIC IN Sensitivity

AF

PC580R/S

PA12

Set the input sensitivity for transmitting the LINE/MIC input to the network. This setting cannot be performed while the Local Broadcasting function is ON.

	Item	Contents
G	LINE/MIC IN Mute	Checking the box mutes the audio to be transmitted from the LINE/MIC input to the network. The LINE/MIC input mute is reflected immediately after the SAVE button is clicked. Initial setting: Unchecked (Unmute)
H	Sensitivity	Set the sensitivity of the LINE/MIC input. Changes in the sensitivity setting are reflected immediately after the SAVE button is clicked. Setting range: 0 (0.0 dB) – 8 (+12.0 dB) Initial setting: 0 (0.0 dB)

(4) SAVE button

Click to save the settings and changes. (See p. 14.)

13.1. Conceptual Diagram of the Sound Volume Settings Function

13.1.1. When Local Broadcasting Function is ON

Please refer to the following diagram for information regarding which volume settings are enabled for each broadcast sound source:

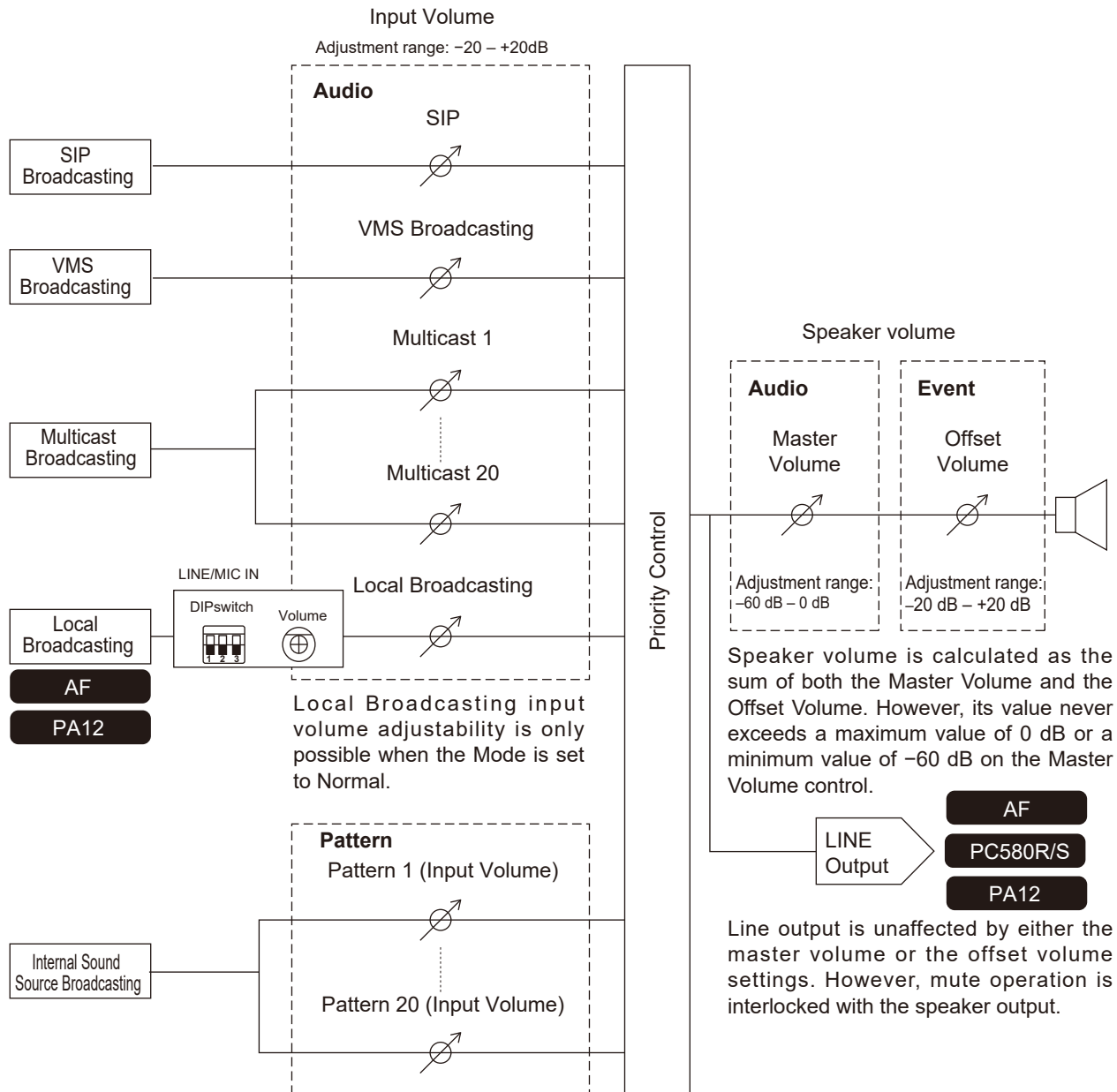

[The trick to successful audio volume settings]

- Take care not to increase the sound source's volume level too much at input. (If the sound source is distorted at this point, distortion cannot be eliminated by subsequent audio settings.)
- Adjust the Input Volume to match the audio volume of the other sound sources.
- Do not increase the Master Volume to maximum output.
(Although device specifications allow it to be used at maximum volume, depending on the sound source input level distortion could occur and the sound quality could be adversely affected.)

13.1.2. When Local Broadcasting Function is OFF

AF

PC580R/S

PA12

Audio volume settings that can be transmitted via the network are:

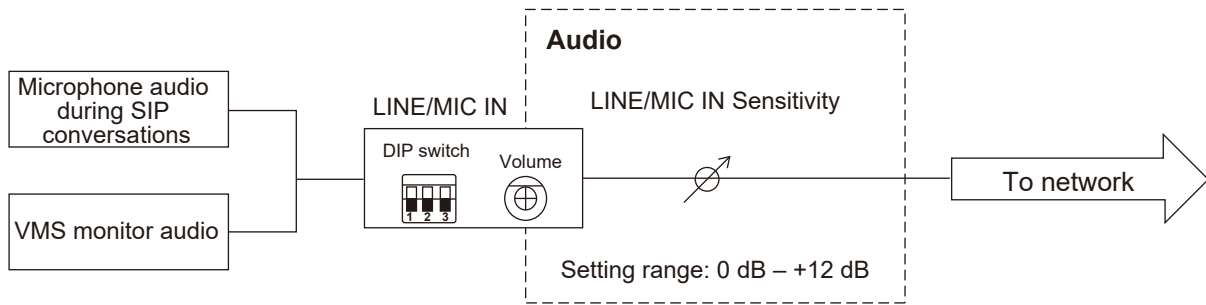

14. MEDIA SETTING SCREEN

This screen is used to upload, download or delete the internal sound source files.

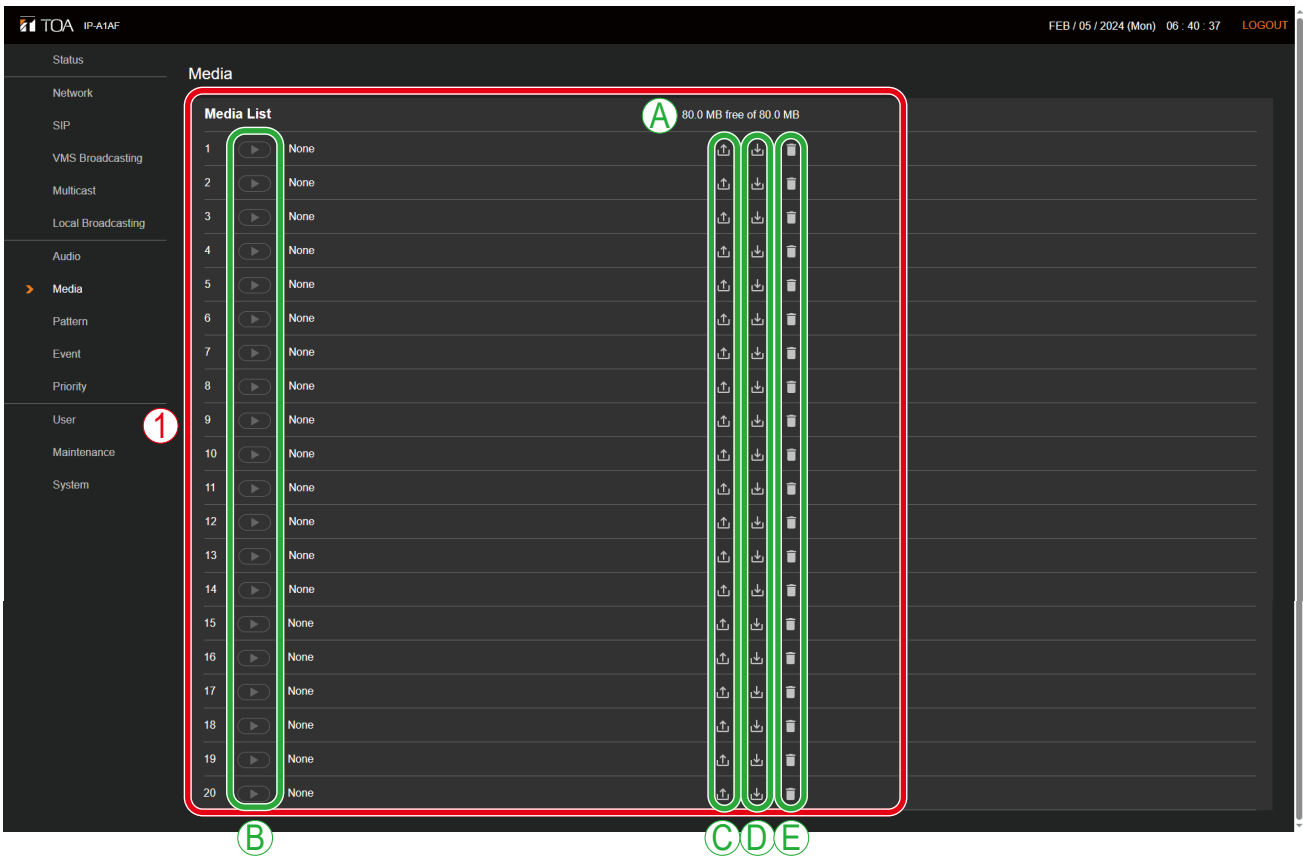

(1) Internal Sound Source List (Media List)

This list shows the names of the sound source files currently stored in the device.

Sound source files can be registered to media numbers 1 – 20. Either MP3 or WAV files can be uploaded to the device.

	Item	Contents
A	Available capacity for internal sound source files	Displays max. device capacity (80 MB) and currently available sound source file upload capacity.
B	Sound Source File Playback Button	All sound source files currently registered on the Internal Sound Source list can be played back by way of a PC, and confirmed as audio. If no sound files are registered, the playback button will not be enabled.
C	Upload Icon	Uploads PC-saved sound source files to the device and adds them to the Internal Sound Source list. (See "Uploading Sound Source Files" on p. 33.)
D	Download Icon	Downloads sound source files from the device and saves them to the PC. (See "Downloading Sound Source Files" on p. 33.)
E	Delete Icon	Deletes sound source files from the device. (See "Deleting Sound Source Files" on p. 34.)

14.1. Uploading Sound Source Files

Follow the procedure below to upload sound source files to the device:

Max. sound source file storage capacity is 30 MB per file and 80 MB total.

Supported file formats are as follows:

WAV file: 8/16/44.1/48 kHz sampling frequency, 8/16 bit, monoaural/stereo

MP3 file: 32/44.1/48 kHz sampling frequency, 64 to 320 kbps, CBR/VBR, monoaural/stereo

Notes

- There are restrictions on the types of characters that can be used for filenames. Files that do not meet these conditions cannot be uploaded. Upload the file after changing the filename to one that consists of only usable characters, referring to "[USABLE CHARACTERS](#)" on p. 59.
- When an internal sound source broadcast is in progress, uploading the sound source file to the same media numbers selected for the in-progress broadcast will cause the broadcast to stop.

Tip

Sound source file format and file size are roughly indicated as follows:

Sound source file format	File size per minute	Approximate sound source length for 30MB file.	Total saveable time (for 80 MB)
WAV (monoaural, 48 kHz, 16 bit)	5.8 MB	About 5 minutes	About 14 minutes
WAV (monoaural, 44.1 kHz, 16 bit)	5.3 MB	About 5 minutes	About 15 minutes
WAV (monoaural, 44.1 kHz, 8 bit)	2.6 MB	About 11 minutes	About 30 minutes
MP3 (monoaural, 320 kbps)	2.4 MB	About 12 minutes	About 33 minutes
MP3 (monoaural, 256 kbps)	1.9 MB	About 16 minutes	About 42 minutes
MP3 (monoaural, 192 kbps)	1.4 MB	About 21 minutes	About 56 minutes
MP3 (monoaural, 128 kbps)	1.0 MB	About 32 minutes	About 83 minutes

Note that the above times are only provided as a guide. Total times may be shorter than those indicated, depending on the recording device or the data creation method.

Step 1. Click on the Upload icon  to the right of the media number to be saved.
The file explorer opens.

Step 2. Select the sound source file to be uploaded to the device.

Step 3. Click on the OK button.
Upload begins.

Following upload completion, the new sound source filename is added to the displayed Internal Sound Source list.

14.2. Downloading Sound Source Files

Follow the procedure below to download sound source files:

Step 1. Click on the Download icon  to the right of the media number to be saved to the PC.
The file explorer opens.

Step 2. Select the folder where the file will be saved.

Step 3. Click on the OK button.
The selected sound source file is downloaded.

14.3. Deleting Sound Source Files

Follow the procedure below to delete sound source files:

Note

When the sound source file being used for an internal sound source broadcasting is deleted, the broadcast will stop.

Step 1. Click on the Delete icon  to the right of the media number to be deleted. The dialog box is displayed.

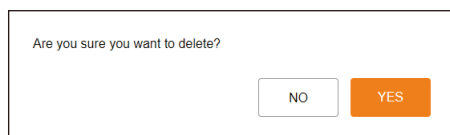

Step 2. Click on the YES button. The selected sound source file is deleted.

15. PATTERN REGISTRATION SCREEN

Up to 20 internal sound source files can be registered as a broadcast pattern for broadcast in synchronization with specific events.

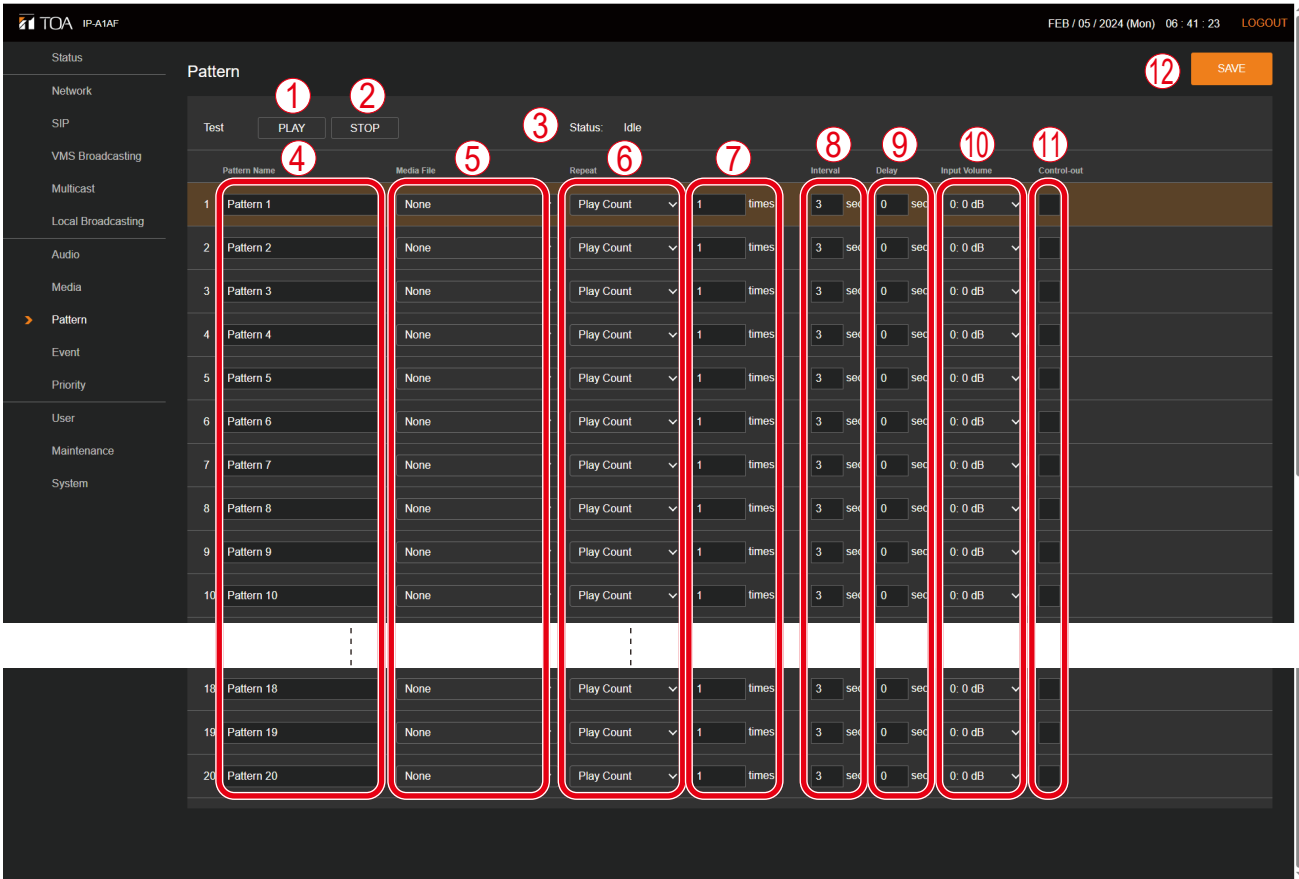

[When Duration is selected in the Repeat setting (6)]

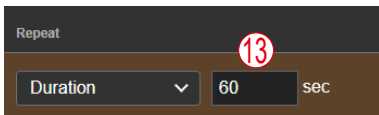

[When Timer is selected in the Repeat setting (6)]

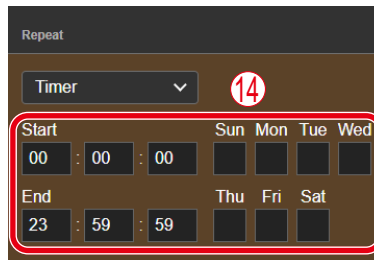

Item	Contents
(1) PLAY button	Test broadcasts can be run to check how the set patterns will be broadcast. Click PLAY button, and audio will be output from both the speaker and the LINE OUT terminals. Tip If the pattern is set to Timer, the sound source will only be played once. Broadcast repetition is not possible.
(2) STOP button	The test broadcast can be stopped by clicking this button.
(3) Status	Displays the device's operating status. Displays the sound source being broadcast when the unit is in broadcast mode. (See p. 19)
(4) Pattern Name*	Assigns a name to each pattern. Initial setting: Pattern 1 – 20

* For more information on the characters or number of characters that can be set, please refer to "USABLE CHARACTERS" on p. 59.

	Item	Contents
(5)	Media Files (Internal sound source files)	Select the internal sound source files to be broadcast in each pattern. Initial setting: None
(6)	Repeat	Select the type of broadcast repetition from among the following three patterns: Play Count: Designate the number of times the broadcast is repeated. Duration: Designate the length of time that the broadcast is repeated. Timer: Designate the start and end times for the repeated broadcast. The broadcast will continuously repeat for the period between these fixed times. Initial setting: Play Count Note If the repeat pattern is designated as Timer, it cannot be controlled by Event Action or Remote API. All operations registered to Timer are performed according to the assigned timer settings.
(7)	Play Count	This function's settings are enabled if Play Count is selected in the Repeat setting (6). Set the number of broadcast repetitions to be executed following input of the Event Trigger. Setting range: 1 – 10 (times) Initial setting: 1 (time)
(8)	Interval	Set the sound source's play interval (the interval from the end of play to the start of the next repetition) when performing repeated broadcasting. Setting range: 0 – 99 (sec.) Initial setting: 3 (sec.)
(9)	Delay	Set the delay time from the input of the Event Trigger to the start of play. This can be used if the beginning of a broadcast is cut off or in similar situations. Setting range: 0 – 99 (sec.) Initial setting: 0 (sec.)
(10)	Input Volume	The input volume can be set to equalize the sound output of individual patterns or change the output level for each pattern. Changes to the input volume settings are enabled from the next broadcast after such changes are saved. Setting range: –20 to +20 dB Initial setting: 0 dB
(11)	Control-out	Connected external equipment can be controlled by transmitting a signal from the control output during broadcasts of internal sound source files. If the checkbox at right is marked, the external control output turns ON when the device begins broadcasting internal sound source files, and turns OFF when the broadcast is stopped. Initial setting: Unchecked
(12)	SAVE button	Click to save the settings and changes. (See p. 14.)
(13)	Duration	This function is enabled if Duration is selected in the Repeat setting (6). Set the length of time the broadcast will be repeated following input of the Event Trigger. Setting range: 5 – 3600 (sec.) Initial setting: 60 (sec.)
(14)	Timer	This function is enabled if Timer is selected in the Repeat setting (6). By performing the following settings, this function can be used as a weekly timer: Start: Set the start time for the repeated broadcast. End: Set the end time for the repeated broadcast. Sun – Sat: Check the days of the week that the broadcast will be repeated. Tip If the broadcast is playing during the period between Start and End times, and a higher priority broadcast is enabled, the ongoing repeated broadcast will be temporarily interrupted and play will resume again after the higher priority broadcast is completed.

The broadcast repetition method can be selected from among the following three variations: Play Count, or the number of times that a broadcast is repeated, the total Duration of the broadcast, and Timer.

Each of these functions can be enabled as follows, depending on the combination with other setting items:

[If Play Count is selected]

Designate the number of times the sound source playback will be repeated. The following operation is performed when Edge is selected as the Signal Mode and the start trigger is a control input, or if the receiving device is externally controlled by remote API.

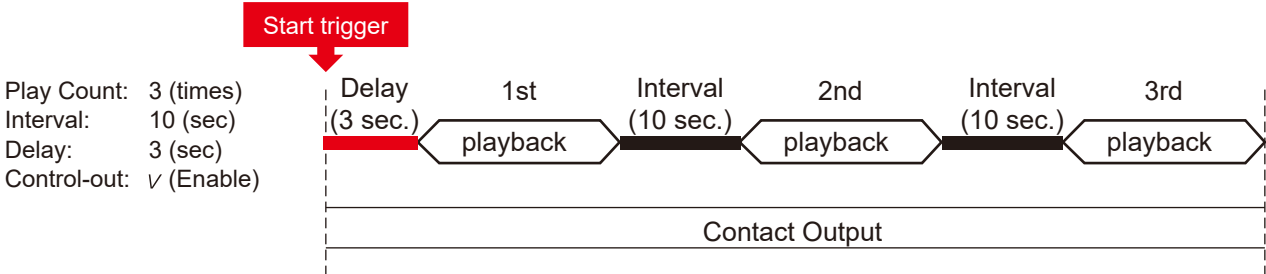

[If broadcast duration is selected]

Designate the duration of repeated play. The following operation is performed when Edge is selected as the Signal Mode and the start trigger is a control input, or if the receiving device is externally controlled by remote API.

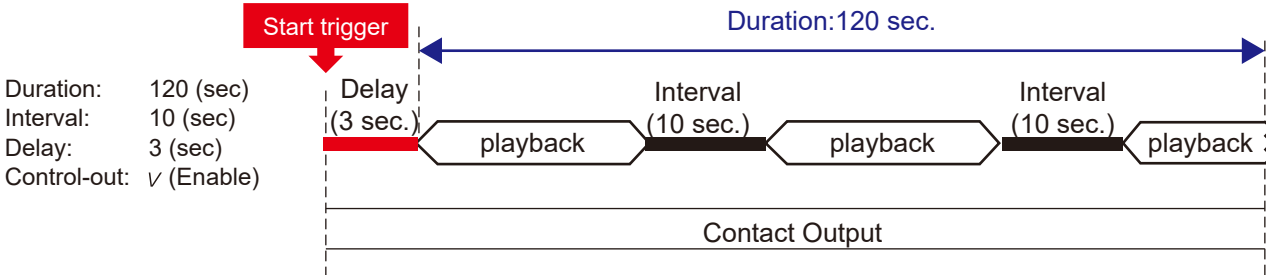

[Controlling Start-to-Finish Duration When the Control Input Signal Mode is Set to Level]

Broadcasts are repeatedly played back with no limit to the number of repetitions when Level is selected as the Signal Mode, even if the Repeat pattern setting is set to "Play Count" or "Duration," for the entire period of time between the initial start trigger and the end trigger. The Interval time setting is applied as the duration between different sound sources.

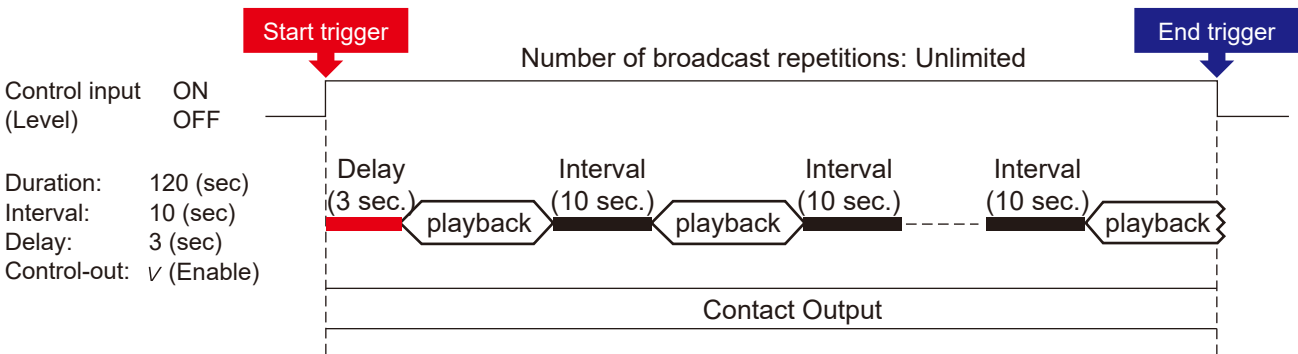

[If Timer is selected]

Designate the repetition start time and end time for the sound source.

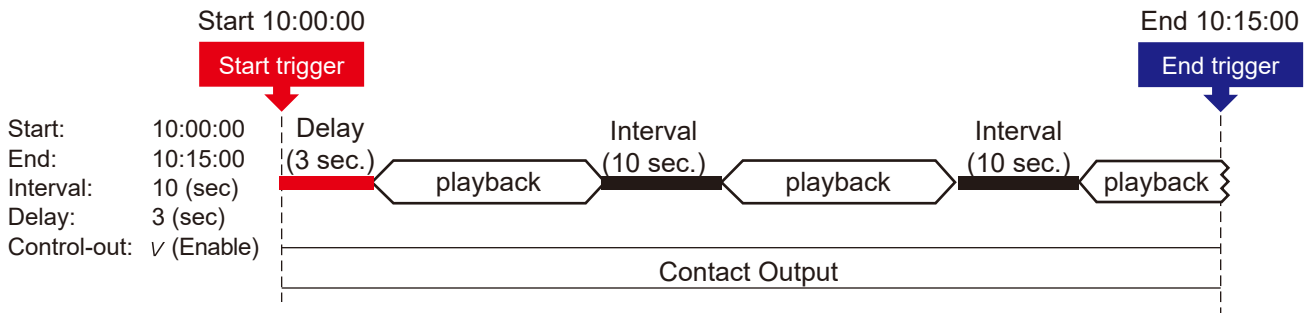

Notes

- Pattern numbers set to Timer will not be enabled, even if set as event actions on the Event Settings screen. Nor can they be externally controlled by Remote API. Instead, to control the pattern by event action or Remote API, set it to Play Count or Duration. Patterns set as Timer are only enabled as determined by the timer settings.
- The start time and end time cannot be set to the same value.

Tips

- If the end time is set to a time earlier than the start time, the broadcast will continue on to the designated end time the following day.
- To play the sound source only once, without performing repeat play, set an end time based on the length of the sound source play.
- If another higher priority broadcast is enabled between the start time and end time, the broadcast will behave as follows:

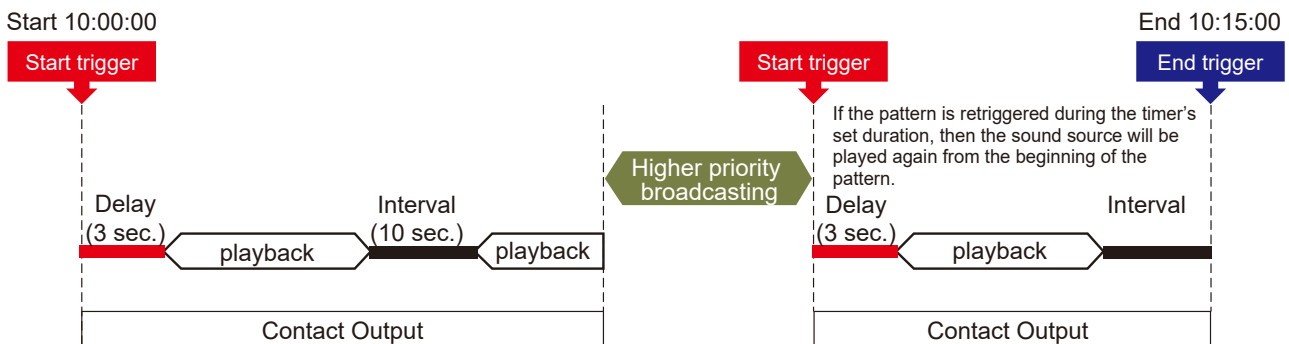

15.1. Performing Tests of Pattern Broadcast

Follow the procedure below to conduct broadcast tests for selected broadcast patterns:

Note

The PLAY button cannot be used if the set contents have not yet been saved.

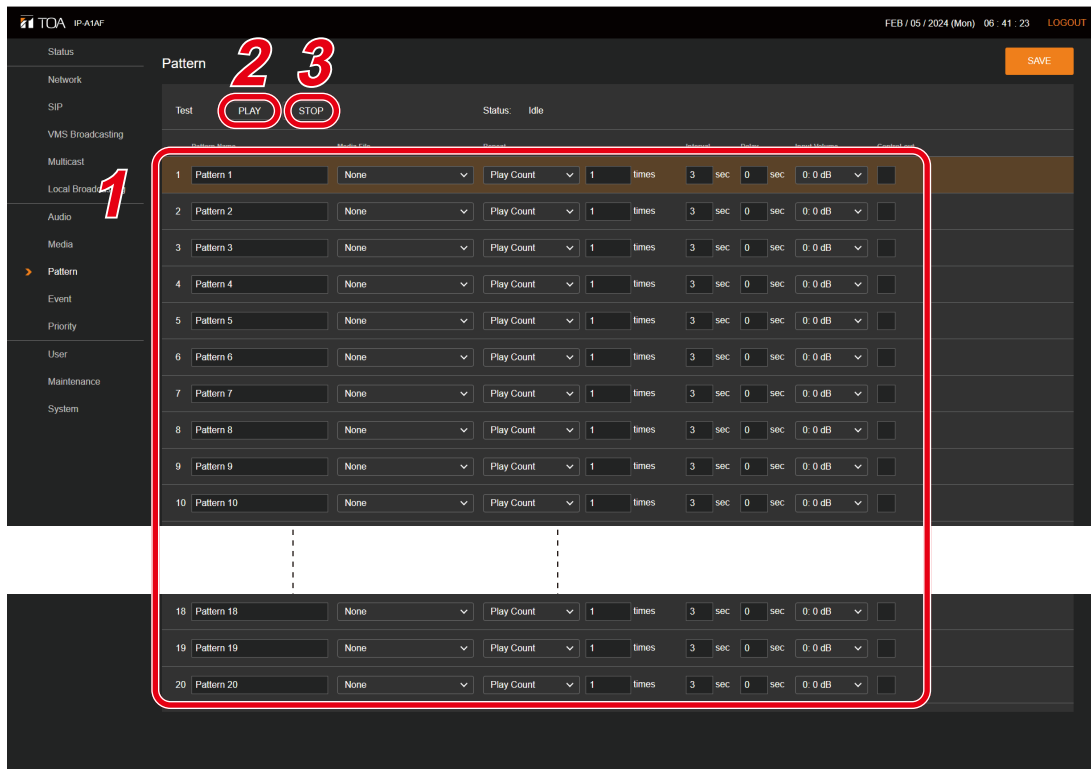

Step 1. Click and select the broadcast pattern to be tested.

Step 2. Click on the PLAY button.

A test broadcast of the selected broadcast pattern will begin.

Step 3. Click on the STOP button to stop the test.

The test broadcast stops.

16. EVENT SETTINGS SCREEN

Perform all settings related to contact control input and output.

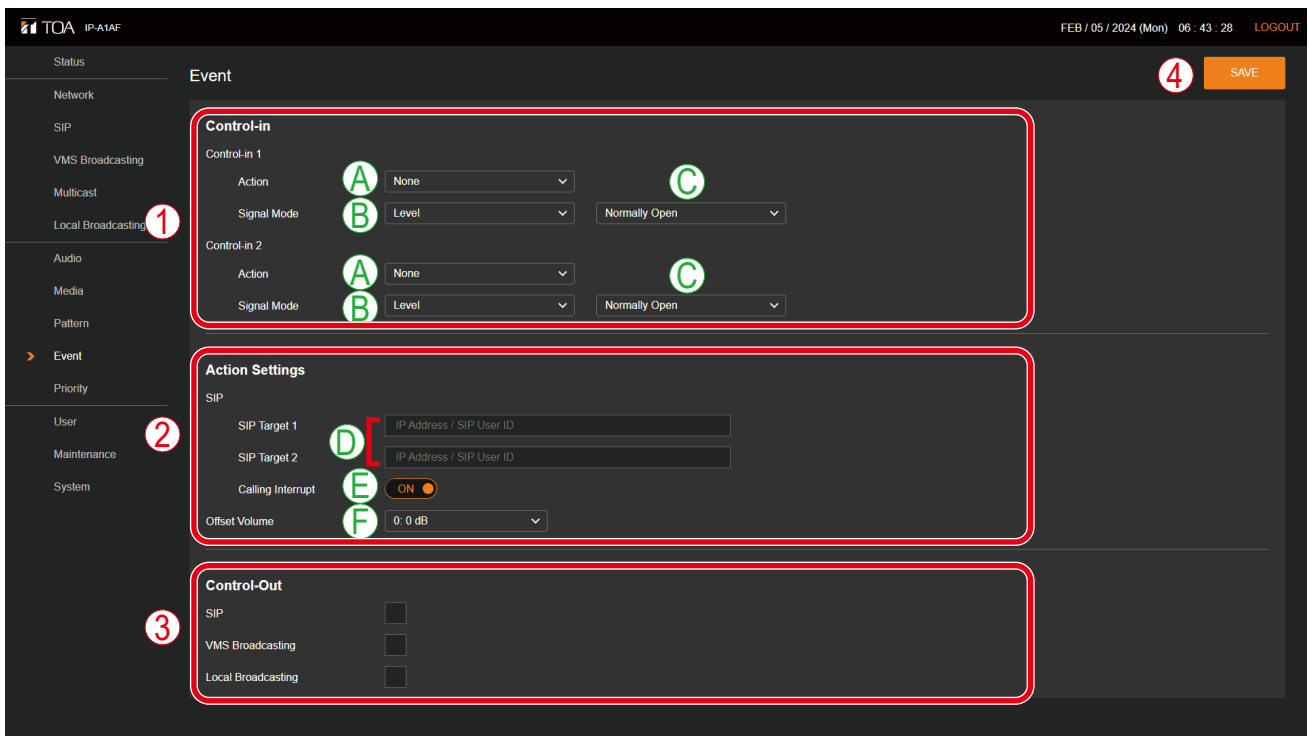

(1) Control-in

Various event actions can be set for each control input, and can be executed by the input of a control signal from connected external equipment.

	Item	Contents
A	Action	Select the action to be executed when a control signal is received. Combinations of selectable actions and individual signal modes are shown in the following table. Initial setting: None Note The same Action cannot be duplicated for the control input (Control-in 1, 2).
B	Signal Mode	Set the signal mode of the control signal. Level: The designated action is only executed while the control signal is ON. The action is terminated when the control signal is OFF. Edge: Only the start trigger (that switches ON the control signal) is detected. Initial setting: Level
C	Control Condition	Set the control signal's control conditions. Normally Open: The circuit is normally disconnected (open), and turns ON when shorted. (Make contact) Normally Closed: The circuit is normally shorted (closed), and turns ON when opened. (Break contact) Initial setting: Normally Open

Configurable actions are as follows;

Note

The same Action cannot be duplicated for the control input (Control-in 1, 2).

Configurable actions	Contents	Level	Edge
None	No action set.	—	—
Pattern 1 – 20	Initiates pattern broadcasting with internal sound source. Note Pattern numbers set to Timer will not be enabled, even if set as an event action on the Event Settings screen. Instead, set the pattern to Play Count or Duration. Any patterns set to Timer are only enabled as determined by the timer settings.	✓*1	✓
SIP 1 – 2	Initiates SIP calls to SIP devices set for SIP Target 1 or SIP Target 2.	—	✓
Local Broadcasting AF PA12	Starts and stops Local broadcasting.	✓	—
Offset Volume	Applies the Offset volume whenever a control signal is being received. The amount of audio volume offset is determined by the Action settings.	✓	—
Speaker Mute	Mutes audio output to the speaker and LINE OUT terminals while the control signal is being received.	✓	—
External Amplifier PA12	During control signal input, the external amplifier signal input is output through the speaker output terminals.	✓	—

*1 Broadcasts are repeatedly played back with no limit to the number of repetitions when Level is selected as the Signal Mode, even if the Repeat pattern setting is set to “Play Count” or “Duration,” for the entire period of time between the initial start trigger and the end trigger. The Interval time setting is applied as the duration between different sound sources.

(2) Action Settings

Various event actions can be set for each control input, and can be executed by the input of a control signal from connected external equipment.

	Item	Contents
D	SIP Target 1, 2*2	Set the SIP calling destination with either the IP address or SIP user ID. Initial setting: Blank space
E	Calling Interrupt	When designating a SIP call as an event action, even if a SIP broadcast is already in progress or a SIP conversation is ongoing, the call will interrupt them and be allowed to go through. Tip If the other device in the SIP connection is the same as the event action-initiated SIP calling destination, the connection will be retained and call interruption will not be executed. Initial setting: ON
F	Offset Volume	Set the amount of Offset volume to apply when Offset Volume is selected as an action. Setting range: -20 to +20 dB Initial setting: 0 dB

*2 For more information on the characters or number of characters that can be set, please refer to "USABLE CHARACTERS" on p. 59.

(3) Control-out

Connected external equipment can be operated by trigger signals transmitted from the control output during device broadcasts.

Set which type of received broadcast will turn on the control output.

If the checkbox to the right of the SIP and VMS Broadcasting indications is marked, the external control output turns ON when the device begins broadcasting, and turns OFF when the broadcast stops.

(Multiple selections possible.)

Initial setting: Unchecked

Tip

Regarding control output settings when broadcasting internal sound source files, refer to "Control output (7)" in the preceding Pattern Registration screen (p. 35).

For more information regarding control output operation during Multicast broadcasting, please read Control Output on the Multicast Settings screen (p. 25).

(4) SAVE button

Click to save the settings and changes. (See p. 14.)

[Broadcasting from the internal sound source (when selecting Patterns 1-20)]

Note

Pattern numbers set to Timer will not be enabled, even if set as an event action on the Event Settings screen. Instead, set the pattern to Play Count or Duration. Any patterns set to Timer are only enabled as determined by the timer settings.

Tip

Pattern Broadcasting, as described below, refers to broadcasts made by playing a pattern list previously set on the Pattern Registration screen. The pattern list can include combinations of selections and repeated play of sound sources, as well as delay, interval, input volume, enabling or disabling of control outputs, etc.

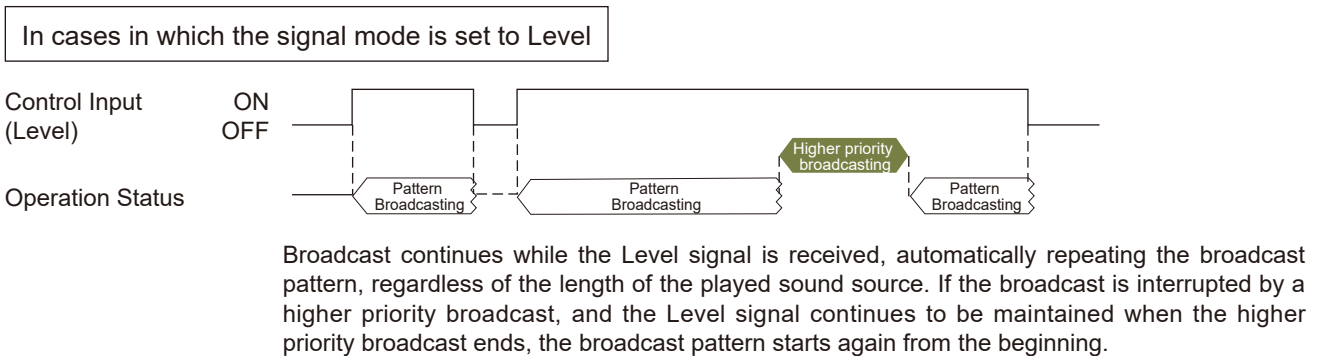
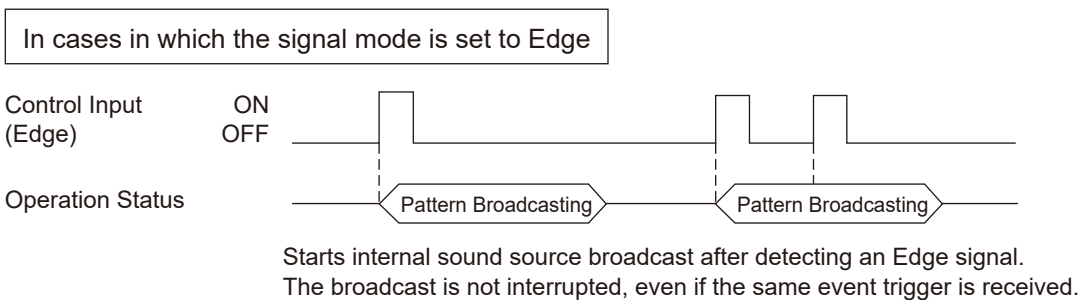

Tip

Broadcasts are repeatedly played back with no limit to the number of repetitions when Level is selected as the Signal Mode, even if the Repeat pattern setting is set to "Play Count" or "Duration," for the entire period of time between the initial start trigger and the end trigger. The Interval time setting is applied as the duration between different sound sources.

[Making calls to a SIP phone (when SIP 1 and/or SIP 2 are selected)]

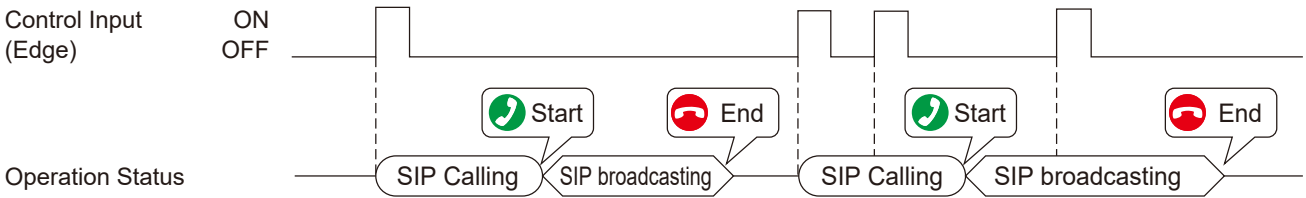

Makes a call to a SIP phone when the Edge signal is detected. Performing call reception at the call destination SIP phone causes the SIP broadcast to begin. When the SIP phone conversation is terminated, the SIP broadcast also ends. Even if the same event trigger is received during the SIP call or SIP broadcasting, the call or broadcast is not interrupted.

[Performing Local Broadcasting (when Local broadcasting is selected)]

AF PA12

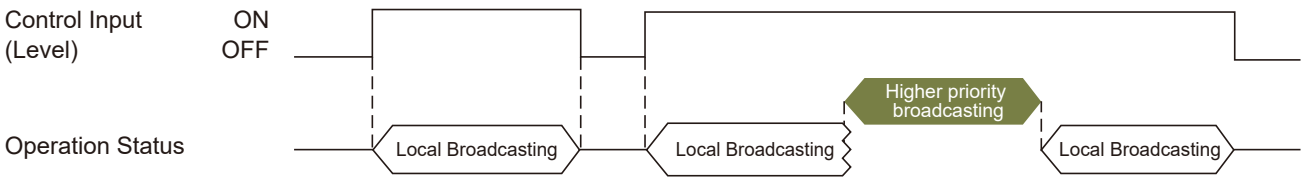

Local broadcasting continues as long as the Level signal is being received. If the broadcast is interrupted by a higher priority broadcast and the Level signal continues to be maintained when the higher priority broadcast ends, Local broadcasting will restart again.

[Audio volume control (when Offset Volume or Speaker Mute is selected)]

When the speaker volume is offset

Master Volume : 31 (-30 dB)
Offset Volume : 6 (+6 dB)



Offset Volume is applied while the Level signal is being received. Offset Volume is also applied to the audio of the ongoing broadcast in real time. This enables the audio volume control to be linked to the control input.

When the speaker volume is muted

Master Volume : 31 (-30 dB)

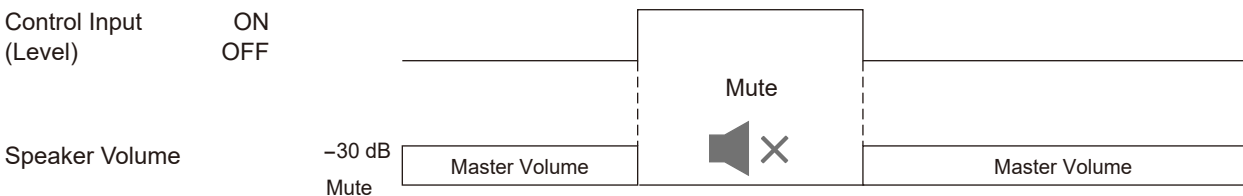

The speaker volume is muted while the Level signal is being received. The line output is also muted. Due to this, the audio volume control to be linked to the control input is made possible.

[Enabling External Amplifier (when External Amplifier is selected)]

PA12

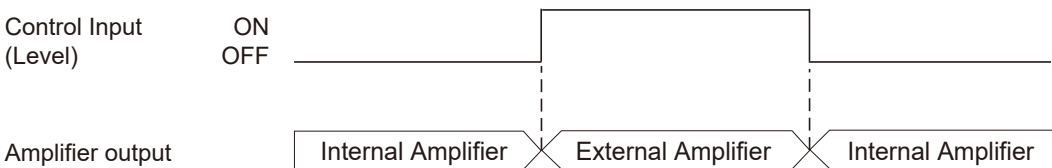

When a level signal is input, the external amplifier is enabled and its signal is output through the speakers. Switching between the internal amplifier and the external amplifier is carried out regardless of the operating status of the receiving device, except when the receiving device is in system mute mode.

17. PRIORITY SETTINGS SCREEN

The priority order of each broadcast function can be set or modified.

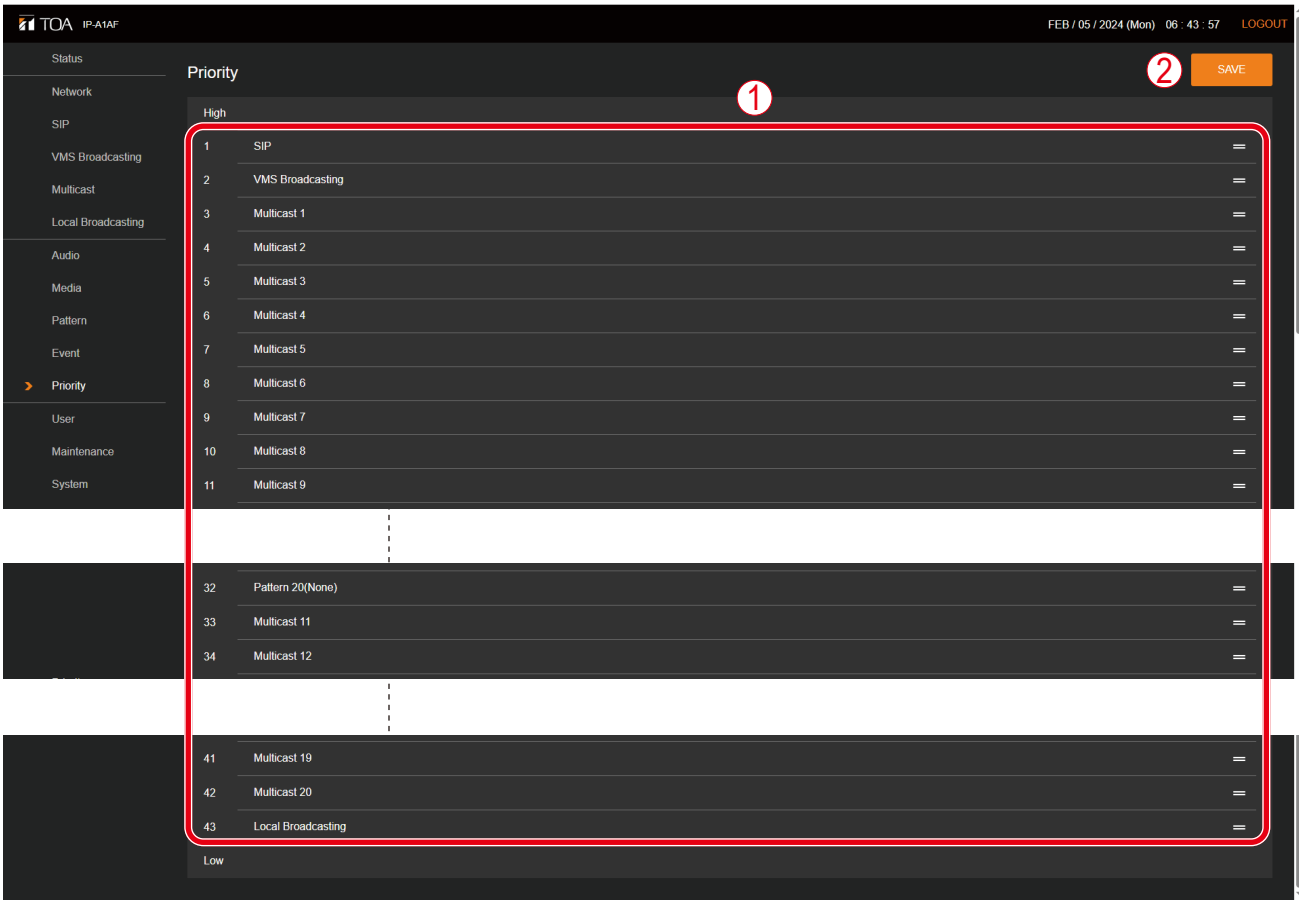

	Item	Contents
(1)	Priority Broadcast	<p>Broadcast priorities can be changed by swapping places in the displayed order. The broadcast priority rises as its displayed position in the list moves upward, while the priority level lowers as the displayed position moves downward. The display order can be changed by drag & drop. For operation, please refer to "About broadcast switching due to broadcast priority settings" on p. 45.</p> <p>Initial Priority settings:</p> <p>[High] SIP VMS broadcasting Multicast 1 – 10 Pattern 1 – 20 Multicast 11 – 20</p> <p>[Low] Local broadcasting AF PA12</p>
(2)	SAVE button	Click to save the settings and changes. (See p. 14.)

[About broadcast switching due to broadcast priority settings]

By assigning a higher priority to a broadcast sound source, it can be set to interrupt other broadcasts. Shown below are some representative examples:

Tip

The Patterns described below represent broadcasts made by executing the pattern list set on the Pattern Registration screen. The pattern list includes the combinations of selections and repeated play of sound sources, as well as delay, interval, input volume, enabling or disabling of control outputs, etc.

Internal sound source broadcast switching operations

Example 1. When the signal mode is set to Edge:

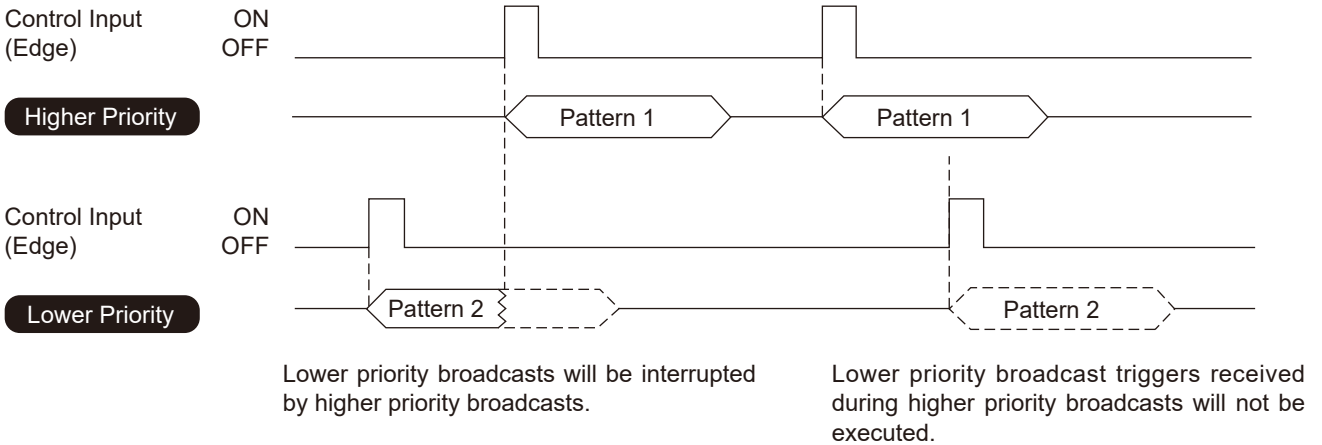

Example 2. When the signal mode is set to Level:

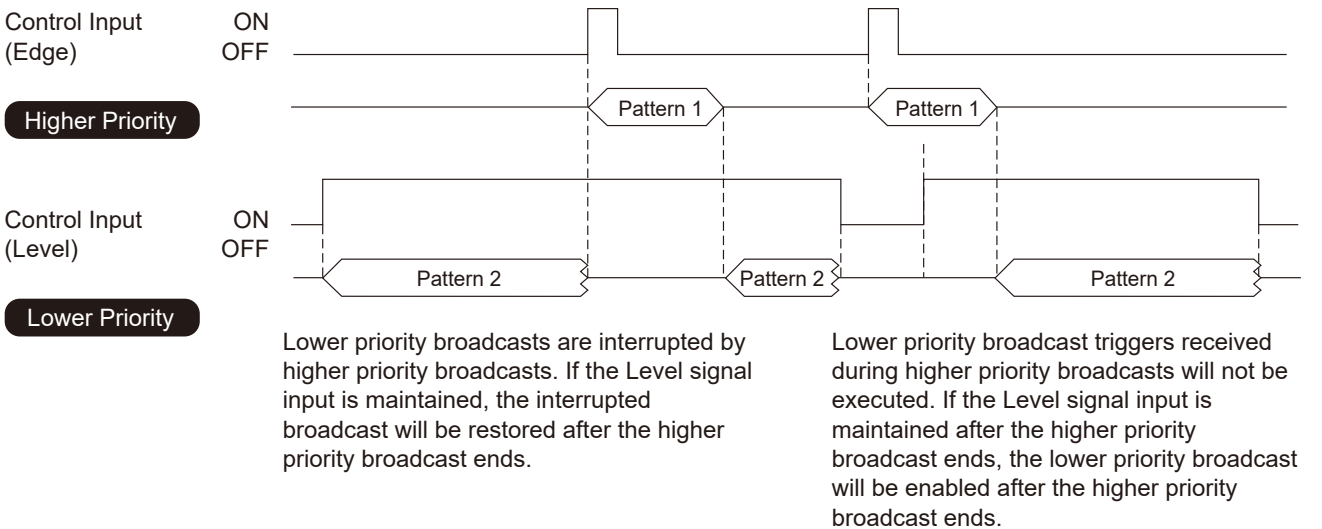

Local broadcast switching operations

AF

PA12

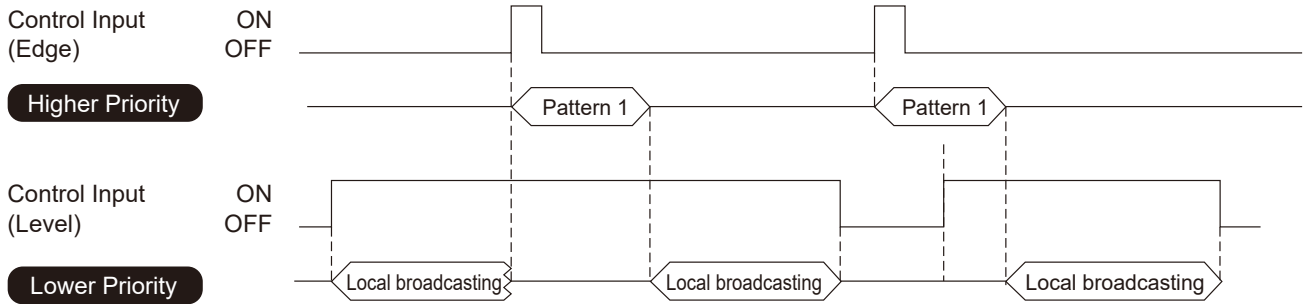

Lower priority Local broadcasts are stopped by higher priority broadcasts. If the Level signal input is maintained, the Local broadcasting will be restored after the higher priority broadcast ends.

Lower priority Local broadcasting triggers received during a higher priority broadcast are not executed. If the Level signal input is maintained after the higher priority broadcast ends, the lower priority Local broadcasting will be enabled after the higher priority broadcast ends.

SIP and VMS broadcast switching operations

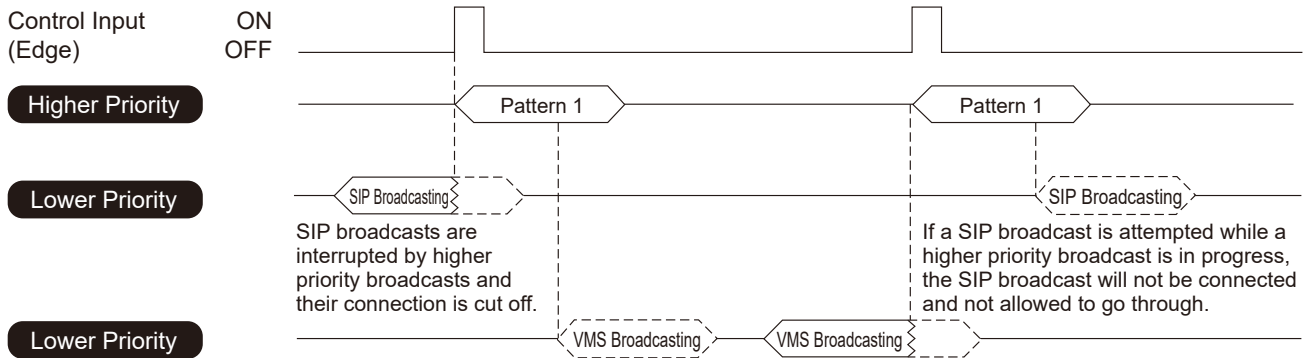

If a VMS broadcast is attempted while a higher priority broadcast is in progress, the VMS broadcast will not be connected and not allowed to go through.

VMS broadcasts are stopped by higher priority broadcasts and their connection is cut off.

Multicast broadcasting switching operations

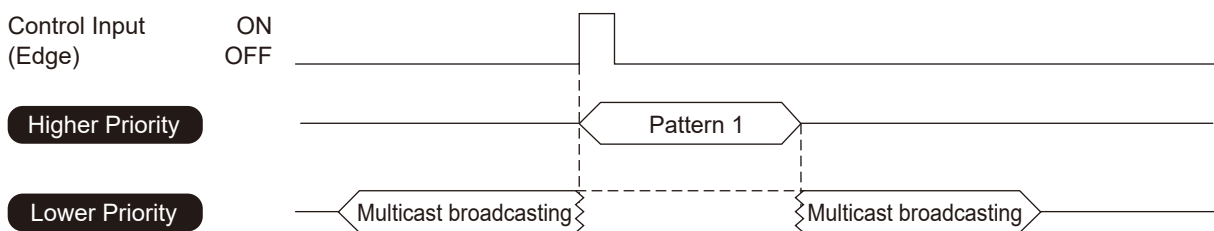

Lower priority Multicast broadcasts are stopped by higher priority broadcasts. If Multicast broadcasting packets have been received at the end of the higher priority broadcast, the Multicast broadcasting is restored.

18. USER SETTINGS SCREEN

The username and password required to make a connection to the device from a PC can be set on this screen.

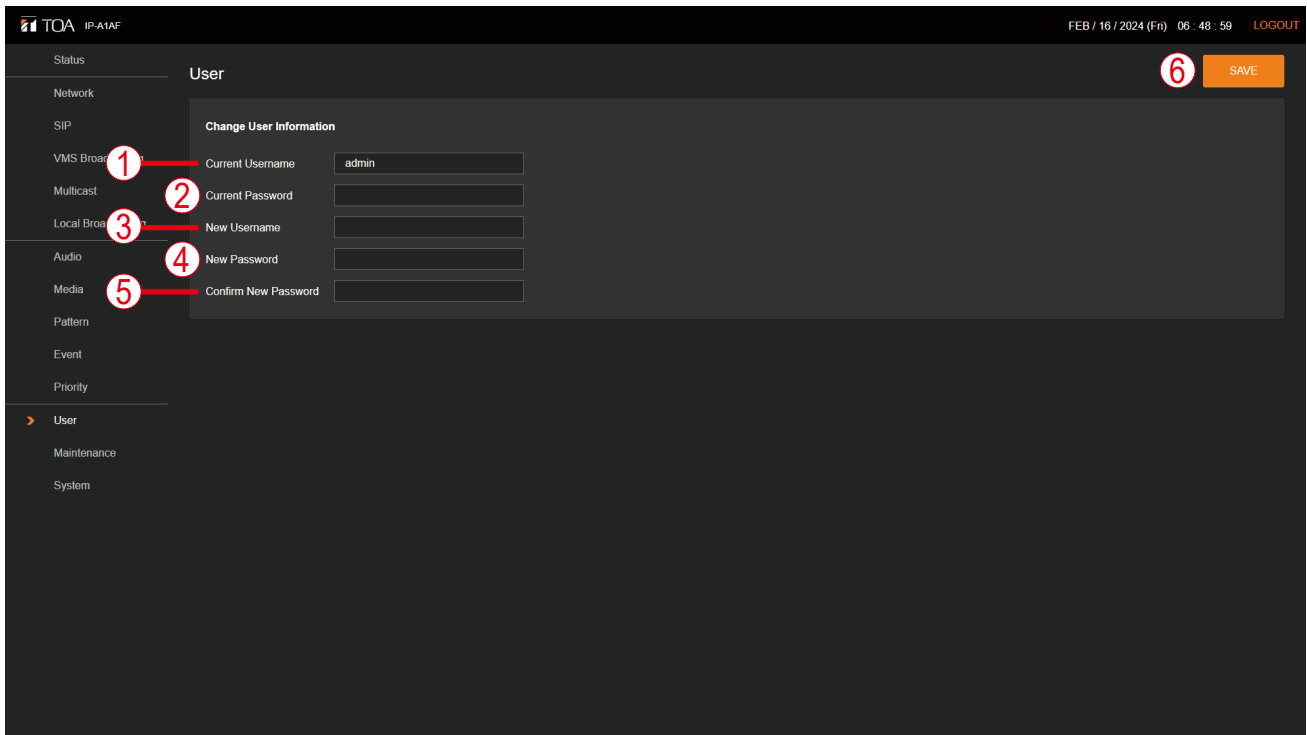

	Item	Contents
(1)	Current Username* ¹ , * ²	Enter the current user account name. Initial setting: admin
(2)	Current Password* ¹ , * ²	Enter the current user account password. Initial setting: guest
(3)	New Username* ¹	Enter the new user account name.
(4)	New Password* ¹	Enter the new user account password.
(5)	Password Confirmation* ¹	Enter the new user account password once again.
(6)	SAVE button	Click to save the settings and changes. (See p. 14.)

*¹ For more information on the characters or number of characters that can be set, please refer to "[USABLE CHARACTERS](#)" on [p. 59.](#)

*² This item's original setting value is retained when the setting file is uploaded.

19. MAINTENANCE SCREEN

Backup and restoration of device settings data, reset setting, firmware update and hardware reboot can all be performed on this screen.

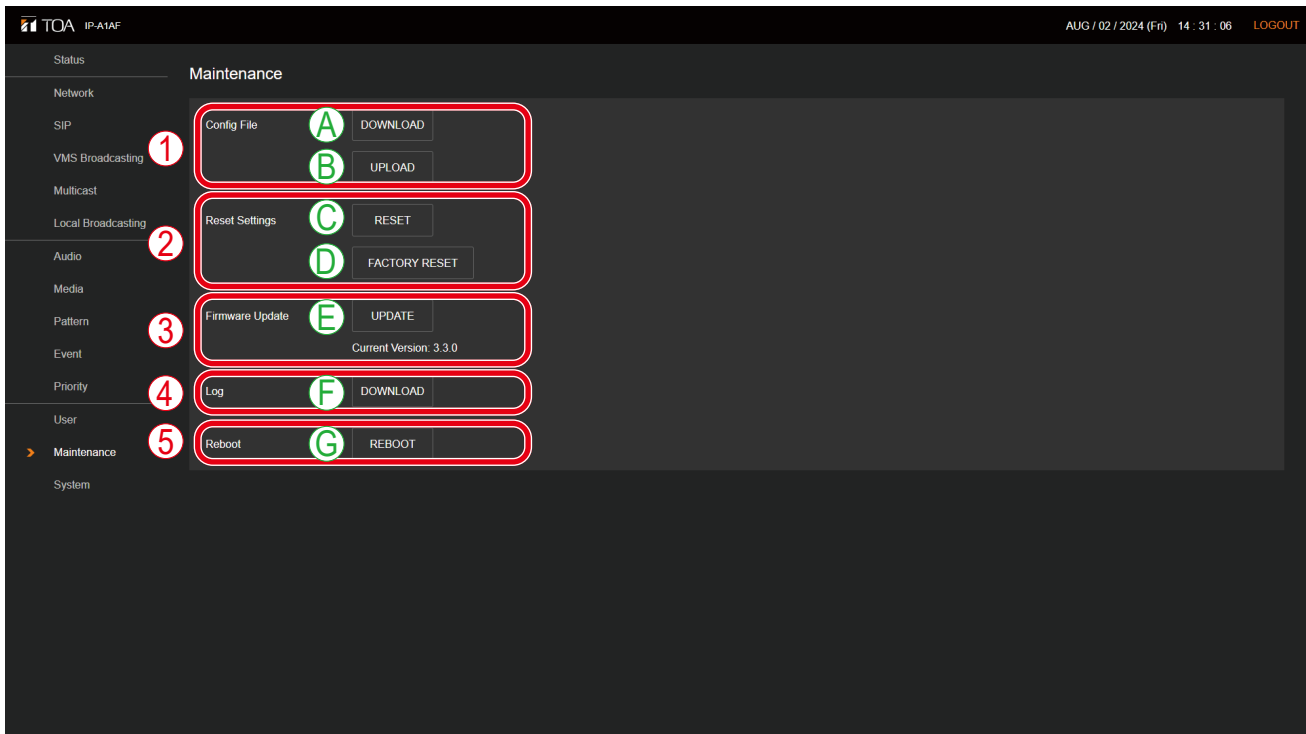

(1) Config File

	Item	Contents
A	DOWNLOAD	The device's settings and sound source files can be downloaded to a connected PC as a single setting file.
B	UPLOAD	By uploading the previously downloaded setting file from the PC, the setting contents and sound source files can be restored to their previous state. Note User and network settings are not applied to setting file uploads. These settings prior to upload are maintained.

(2) Reset Setting

	Item	Contents
C	RESET	Resets all of the device's setting contents to their initial setting status. However, sound source files saved within the device are retained on the Media Settings screen without being deleted.
D	FACTORY RESET	Resets all of the device's setting contents to their initial status as shipped from the factory. Internally saved sound source files will also be deleted.

(3) Firmware Update

	Item	Contents
E	UPDATE	The device's firmware can be updated by running the firmware-updater previously saved to the connected PC. The device's current firmware version is displayed in the Current Version box.

(4) Log

	Item	Contents
F	DOWNLOAD	The device's operation logs can be downloaded to a PC.

(5) Reboot

	Item	Contents
G	REBOOT	Restarts the device. Use this button when applying setting changes or performing other operations that require restart.

19.1. Downloading Setting File

Follow the procedure below to save the device's setting contents and sound source files to the PC as setting files:

Step 1. Click on the DOWNLOAD button.
The file explorer opens.

Step 2. Select the folder into which the setting file is to be saved.

Step 3. Enter the filename and click on the SAVE button.

Tip

The setting file extension is ".spconf".

The following filename is automatically assigned when downloading:

<IP address>_<terminal name>.spconf

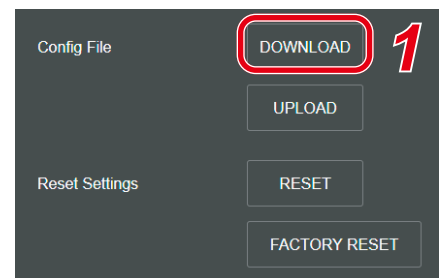

19.2. Uploading Setting File

Follow the procedure below to restore setting contents and sound source files to the device from the setting files saved on the PC.

Note

Performing uploads during a broadcast will stop all current broadcasts.

Step 1. Click on the UPLOAD button.

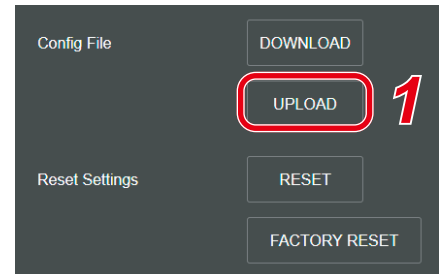

The settings upload screen opens.

Step 2. Click on the Browse button.

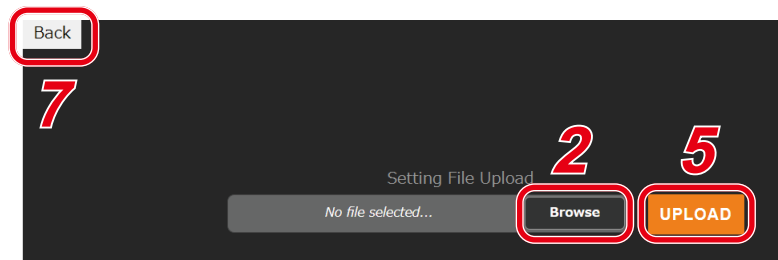

The file explorer opens.

Step 3. Select the setting file.

Tips

- The setting file extension is ".spconf".
- For valid characters that can be used in the file name, please refer to ["USABLE CHARACTERS" on p. 59.](#)

Step 4. Click on the OPEN button.

Step 5. Confirm the setting filename displayed on the screen, then click on the UPLOAD button. Upload begins, followed by an automatic restart. A popup window showing the operating status is displayed during upload or restart. During this process, a confirmation dialog is temporarily displayed when upload of the setting file is complete.

Note

The transmitting device's settings file cannot be uploaded to the receiving device.

Step 6. Click on the OK button. After restart is complete, the popup window showing the operating status turns off, returning the display to the Settings Upload screen.

Step 7. Click on the BACK button located at the upper left of the Settings upload screen. The display then reverts to the Login screen.

19.3. Initialization of Settings

Follow the procedure below to return all the device's setting contents to their initial settings.

Notes

- Unlike the factory default settings procedure described on the following page, the device's saved sound source files are not deleted.
- The firmware version does not revert to the factory-preset version. The version that existed before settings initialization is maintained.

Step 1. Click on the RESET button.

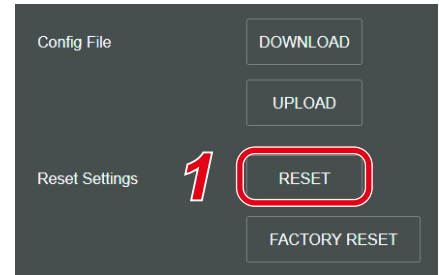

The dialog box opens.

Step 2. Click on the YES button.

The initialization of all the device's settings begins.
The dialog box is displayed when initialization is completed.



Step 3. Click on the OK button.

Step 4. Restart the device.

If Restart is executed, all of the device's new settings will be initialized after the device is restarted.
For the restart method, please refer to "[Restarting the Device](#)" on p. 15.

Tip

Settings can also be initialized by using the device's Reset key. For detailed setting procedure, please refer to the instruction manual supplied with the device.

19.4. Factory Default Settings

Follow the procedure below to return all the device's settings to their factory-preset condition.

Notes

- If returned to factory default settings, all of the sound source files saved in the device will also be deleted.
- The firmware version does not revert to the factory-preset version. The version that existed before settings initialization is maintained.

Step 1. Click on the FACTORY RESET button.

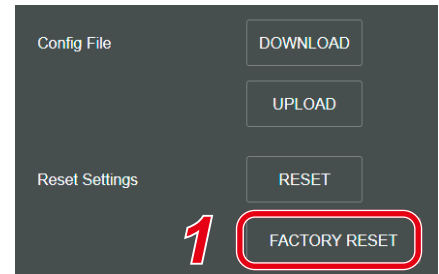

The dialog box opens.

Step 2. Click on the YES button.
Initialization to factory default setting begins.
The dialog box is displayed once initialization is complete.



Step 3. Click on the OK button.

Step 4. Restart the device.
If Restart is executed, the device will revert to its initial factory-preset condition after being restarted.
For the restart procedure, please refer to ["Restarting the Device" on p. 15](#).

19.5. Firmware Update

The procedure for updating the device's firmware is as follows:

Tip

Download the latest firmware-updater after performing a search of the TOA DATA Library (<https://www.toa-products.com/international/>) for the product number.

Note

Do not change the filename of the downloaded firmware-updater.

Step 1. Click on the UPDATE button.

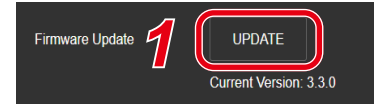

The Update screen opens.

Step 2. Click on the Browse button.
The file explorer opens.

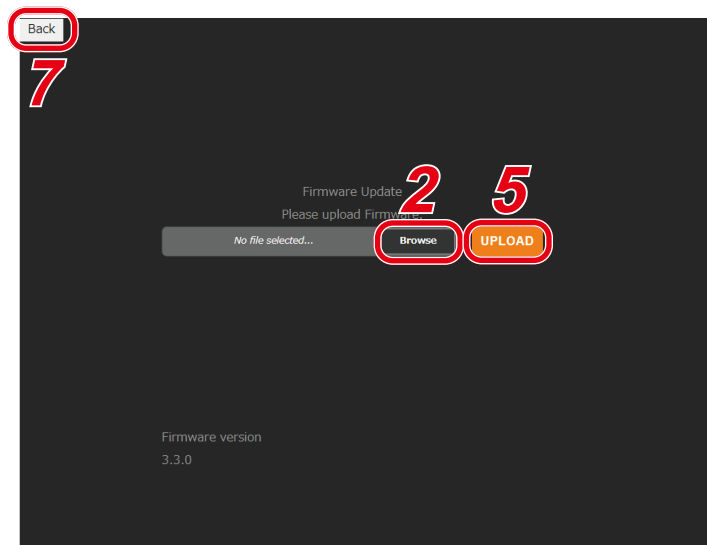

Step 3. Select the new firmware-updater file.

Tip

The firmware-updater's extension is ".bin".

Step 4. Click on the OPEN button.

Step 5. Confirm the firmware-updater's name displayed on the screen, then click on the UPLOAD button.
The dialog box is displayed.

Step 6. Click on the OK button.

Upload of the new firmware-updater begins.

After upload is completed, the device's Status indicator changes to indicate that the firmware update is in progress, and the device is restarted.

After restart is completed, the display reverts to the Update screen.

Note

Do not restart the device or turn off its power during firmware update, as doing so could result in corrupted firmware, potentially making it impossible to start the device.

Step 7. Click on the BACK button located at the upper left of the Update screen.
The display reverts to the Login screen.

Step 8. After logging in again, confirm that the new firmware version is displayed in the Firmware Version field on the Status screen.

Tip

After firmware update, all settings and sound source files are maintained without being initialized.

19.6. Downloading the Log File

19.6.1. About the Log File

Clicking on the DOWNLOAD button in the Log field allows the log file to be downloaded. The file name extension is [.log]. The log can be browsed using a text editor like Notepad.



The following filename is automatically assigned when downloading:

<IP address>_<terminal name>.log

Data saved to the log file includes device information and operating log.

Logs are kept for 30 days.

File size can be up to about 15MB.

Device information	[TERMINAL] (Model) IP-A1AF
	[TERMINAL] (HW version) 1
	[TERMINAL] (MAC Address) 00:05:f9:xx:xx:xx
	[TERMINAL] (Name) IP-A1AF
	[TERMINAL] (FW version) x.x.x
	[TERMINAL] (IP Address) 192.168.14.1
	[TERMINAL] (Subnet Mask) 255.255.255.0
	[TERMINAL] (Default Gateway) 0.0.0.0
	[TERMINAL] (DNS Server (Primary)) 0.0.0.0
	[TERMINAL] (DNS Server (Secondary)) 0.0.0.0
----- log -----	
Operating log	[2024/08/22 14:41:57 UTC+0900] [SYSTEM] Start Up
	[2024/08/22 14:42:00 UTC+0900] [AUDIO] Speaker Volume -30 dB
	[2024/08/22 14:42:00 UTC+0900] [AUDIO] Speaker Mute Disable
	[2024/08/22 14:42:00 UTC+0900] [AUDIO] LINE/MIC IN Mute Disable
	[2024/08/22 14:42:00 UTC+0900] [AUDIO] LINE/MIC IN Sensitivity 0.0 dB
	[2024/08/22 14:42:18 UTC+0900] [SYSTEM] Broadcast Function Ready
	[2024/08/22 14:42:19 UTC+0900] [STATUS] Idle
	[2024/08/22 14:43:04 UTC+0900] [STATUS] Pattern 1
[2024/08/22 14:43:07 UTC+0900] [STATUS] Idle	

19.6.2. Log Table

Receiving Device Log	Variable	Log Contents
[SYSTEM]		
Start Up		Receiving device started
Broadcast Function Ready		Broadcast ready
Reboot		Restarted
Changing Date and Time		Start of changing date and time settings
Change Date and Time		Date and time settings changed
NTP Synchronization Start		NTP time synchronization ON
NTP Synchronized (NTP Server #)	NTP server number (1, 2)	NTP time synchronization successful
NTP Synchronization is skipped (The status is not Idle)		NTP time synchronization skipped — Device not in idle state
[ERROR] NTP Synchronization Failed		NTP time synchronization failed
[STATUS]		
Idle		Standby mode ON
SIP Calling		SIP call
SIP		SIP broadcasting ON
VMS Broadcasting		VMS broadcasting ON
Multicast ##	Multicast channel number (1 – 20)	Multicast broadcasting ON
Local Broadcasting		Local broadcasting ON
Pattern ##	Pattern number (1 – 20)	Internal sound source broadcasting ON
System Mute		System mute ON

Receiving Device Log	Variable	Log Contents
[AUDIO]		
Speaker Volume ## dB	Speaker volume value (-60 - 0)	Speaker volume changed
Speaker Mute Enable		Speaker mute ON
Speaker Mute Disable		Speaker mute OFF
LINE/MIC IN Sensitivity ## dB	Sensitivity setting value (0.0 - 12.0)	Audio input sensitivity settings changed
LINE/MIC IN Mute Enable		Audio input mute ON
LINE/MIC IN Mute Disable		Audio input mute OFF
Speaker Output ##	External Amplifier, Internal Amplifier	Speaker output (from external or internal amplifier)
[EVENT]		
Control In # ON (Edge)	Control-in number (1, 2)	Control input turned ON as Edge signal
Control In # ON (Level)	Control-in number (1, 2)	Control input turned ON as Level signal
Control In # OFF (Level)	Control-in number (1, 2)	Control input turned OFF as Level signal
Mute In ON		Mute input ON
Mute In OFF		Mute input OFF
Mute Packet ON		Start of receiving system mute packet
Mute Packet OFF		End of receiving system mute packet
[ACTION]		
No Action		Action to be executed not set
Pattern ## Start	Pattern number (1 - 20)	Internal sound source broadcasting ON
Pattern ## End	Pattern number (1 - 20)	Internal sound source broadcasting OFF (only if Level signal)
SIP # Start	SIP target number (1, 2)	SIP call ON
Local Broadcasting Start		Local broadcasting ON
Local Broadcasting End		Local broadcasting OFF
Offset Volume ##	Offset volume value (-20 - 20)	Master Volume offset value changed
Speaker Mute ON		Speaker mute ON
Speaker Mute OFF		Speaker mute OFF
System Mute Start		System mute ON
System Mute End		System mute OFF
[MAINTENANCE]		
Download Config		Setting file download ON
Upload Config		Setting file upload ON
Reset Settings		Setting reset executed
Download Log		Log download ON
Firmware Update (xxx => yyy)	xxx: Version before updating yyy: Updated version	Firmware update ON
[PATTERN TIMER]		
Pattern ## Start	Pattern number (1 - 20)	Internal sound source broadcasting by Timer ON
Pattern ## End	Pattern number (1 - 20)	Internal sound source broadcasting by Timer OFF
[SIP]		
SIP Server State (xxx)	xxx: Unregistered Registering Registered	SIP Registration Status for error case
SIP Server State (xxx) [yyy:zzz]	xxx: Registration Failed yyy: Error Message zzz: SIP Response Code	SIP Registration Status for error case

Receiving Device Log	Variable	Log Contents
Outgoing (xxx) (yyy)	xxx: Trying Remote Ringing Connected End yyy: Remote SIP ID	SIP outgoing call state
Outgoing (xxx) (yyy) [aaa:zzz]	xxx: Error yyy: Remote SIP ID aaa: SIP Error Message zzz: SIP response code	SIP outgoing call state
Incoming (xxx) (yyy)	xxx: Ringing Connected High Priority Call Accepted Low Priority Call Rejected Rejected Priority End yyy: Remote SIP ID	SIP incoming call state
Incoming (xxx) (yyy) [aaa:zzz]	xxx: Error yyy: Remote SIP ID aaa: SIP Error message zzz: SIP response code	SIP incoming call state

20. SYSTEM SETTINGS SCREEN

Perform date and time and NTP server synchronization settings.

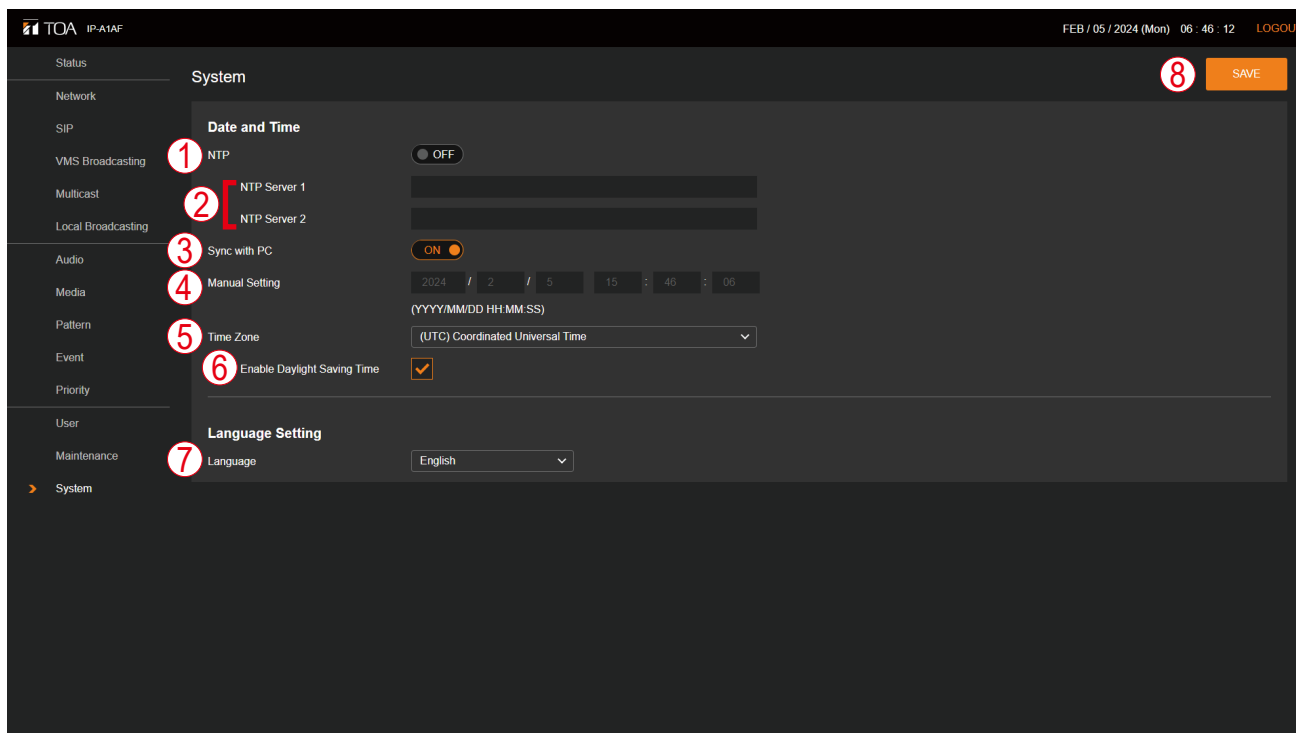

	Item	Contents
(1)	NTP	Setting NTP to ON enables the NTP client function. If a synchronous operation to the NTP server begins, the following contents are displayed: Synchronizing...: NTP synchronization in progress. Synchronized: NTP synchronization succeeded. Synchronization Failed: NTP synchronization failed. Initial setting: OFF Note No synchronization is possible if the receiving device is currently broadcasting.
(2)	NTP Server 1, 2*	Enter the NTP server's IP address or domain to select the server to be synchronized. Initial setting: Blank space
(3)	Sync with PC	If this function is set to ON and the SAVE button (8) is clicked, the device's clock will synchronize with that of the connected PC. This setting is enabled when NTP (1) is set to OFF. Initial setting: ON
(4)	Manual Setting	Set the current time manually. The time is set when the SAVE button (8) is clicked. This setting is enabled when both NTP (1) and Sync with PC (3) are set to OFF.
(5)	Time Zone	Select the time zone of the location where the device is installed. This location will be set when the SAVE button (8) is clicked. Initial setting: (UTC) Coordinated Universal Time
(6)	Enable Daylight Saving Time	Checking this box enables daylight saving time correction in time zones where daylight saving time (DST) is applicable. In time zones where daylight saving time is not used, this time correction is not enabled, regardless of whether the box is checked or not. Initial setting: Checked
(7)	Language	The display language on setting screen in the web browser can be set. Initial setting: English
(8)	SAVE button	Click to save the settings and changes. (See p. 14.)

* For more information on the characters or number of characters that can be set, please refer to "USABLE CHARACTERS" on p. 59.

For the setting method, please refer to "CURRENT DATE AND TIME SETTINGS" on p. 11.

Note

By powering the device for a period of 24 hours or more, the time can be retained for approximately 24 hours in an unpowered state. The current time is not retained in such cases as immediately after the device was purchased or if the device has not been powered for long periods of time. Please make sure to set the current time immediately after purchasing and switching ON the device.

21. USABLE CHARACTERS

21.1. Characters That Can Be Used for Names, Authentication ID and Passwords

Target		Max. number of characters	Alphabetical A – Z a – z	Numerical 0 – 9	Allowable symbols
Login screen	Username	15	✓	✓	× Symbols cannot be used.
	Password	15	✓	✓	
Network settings screen	Terminal Name	31	✓	✓	“!” exclamation “_” hyphen “#” hash “@” at sign “\$” dollar “[” “]” square bracket “%” percent “^” hat “&” ampersand “_” underscore “'” apostrophe “{ ” “}” curly bracket “(” “)” parentheses “~” tilde
SIP settings screen	SIP Server Address	253*1	✓	✓	“_” hyphen “.” dot
	User ID	31	✓	✓	“_” hyphen “_” underscore
	Display Name	31	✓	✓	
	Password	31	✓	✓	“ ” space “:” colon “!” exclamation “;” semicolon “#” hash “< ” “>” unequal sign “\$” dollar “=” equal “%” percent “?” question “&” ampersand “@” at sign “'” apostrophe “[” “]” square bracket “(” “)” parentheses “^” hat “*” asterisk “_” underscore “+” plus “`” back quote “,” comma “{ ” “}” curly bracket “_” hyphen “[” “]” vertical bar “.” dot “~” tilde “/” slash
	Authentication ID	31	✓	✓	“_” hyphen “_” underscore
	Priority SIP Client	31	✓	✓	“_” hyphen “_” underscore “.” dot*2
VMS Broadcasting settings screen	Username	15	✓	✓	× Symbols cannot be used.
	Password	15	✓	✓	
Multicast settings screen	Group Name	32	✓	✓	“ ” space “:” colon “!” exclamation “;” semicolon “#” hash “< ” “>” unequal sign “\$” dollar “=” equal “%” percent “?” question “&” ampersand “@” at sign “'” apostrophe “[” “]” square bracket “(” “)” parentheses “^” hat “*” asterisk “_” underscore “+” plus “`” back quote “,” comma “{ ” “}” curly bracket “_” hyphen “[” “]” vertical bar “.” dot “~” tilde “/” slash
Pattern settings screen	Pattern Name	32	✓	✓	“ ” space “:” colon “!” exclamation “;” semicolon “#” hash “< ” “>” unequal sign “\$” dollar “=” equal “%” percent “?” question “&” ampersand “@” at sign “'” apostrophe “[” “]” square bracket “(” “)” parentheses “^” hat “*” asterisk “_” underscore “+” plus “`” back quote “,” comma “{ ” “}” curly bracket “_” hyphen “[” “]” vertical bar “.” dot “~” tilde “/” slash
Event settings screen	SIP 1 Target	31	✓	✓	“_” hyphen “_” underscore
	SIP 2 Target	31	✓	✓	“_” dot*2

Target		Max. number of characters	Alphabetical A – Z a – z	Numerical 0 – 9	Allowable symbols
User settings screen	Current Username	15	✓	✓	x Symbols cannot be used.
	Current Password	15	✓	✓	
	New Username	15	✓	✓	
	New Password	15	✓	✓	
	Confirm New Password	15	✓	✓	
System settings screen	NTP Server 1	253*1	✓	✓	“-” hyphen
	NTP Server 2	253*1	✓	✓	“.” dot

*1 Please note that a maximum of 63 characters can be used for the label.

*2 Can only be used when entering the address.

Tip

Characters that can be used when entering the "Name (Terminal Name)" with the IP settings tool are the same as those used for the [Terminal Name] on the Network Settings screen shown above.

21.2. Characters That Can Be Used for Filenames

Target		Max. number of characters	Alphabetical A – Z a – z	Numerical 0 – 9	Allowed Symbols
Media settings screen	Media file name (*wav*.mp3)	32*2	✓	✓	“ ” space “!” exclamation “#” hash “\$” dollar “%” percent “&” ampersand “'” apostrophe “(” “)” parentheses “+” plus “,” comma “-” hyphen “.” dot “;” semicolon “=” equal “@” at sign “[” “]” square bracket “^” hat “_” underscore “`” back quote “{ ” “}” curly bracket “~” tilde
Maintenance screen	Config file name (*spconf)	128*2	✓	✓	

*2 File extensions are also included in the total number of characters.

Tip

Characters that can be used for filenames when performing "Setting Upload" by means of the IP settings tool are the same as those used for the "Config filename" on the Maintenance screen shown above.

22. IP SETTING TOOL

The IP Setting Tool allows multiple devices to be efficiently set up. It also makes it possible to save the setting contents to the PC or upload to the device settings contents stored on the PC. Using this function, the same settings can also be duplicated onto multiple devices. Only use the IP Setting Tool while both the PC and the device are connected to the same network segment. (See "[CONNECTION WITH BROWSER](#)" on p. 10.)

22.1. Before Using:

On the TOA DATA Library (<https://www.toa-products.com/international/>), perform a search for the product number of the device and download the "IPSettingTool.exe" IP Setting Tool. The following shortcut icon appears on the desktop:



22.2. Starting the IP Setting Tool

Double-click on the "IPSettingTool.exe" icon.

Notes

- When the PC has access to multiple network adapters, the confirmation screen as shown at right is displayed. Select the network adapter that can be connected to the device and click on the OK button.

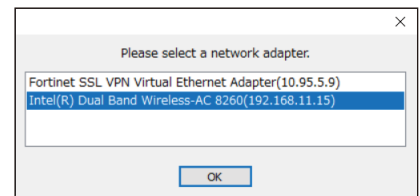

- When the IP Setting Tool is enabled and all connected IP Audio devices are automatically detected and displayed in the list, as shown in the following screen, the right-side buttons appear grayed-out and are rendered inoperative.

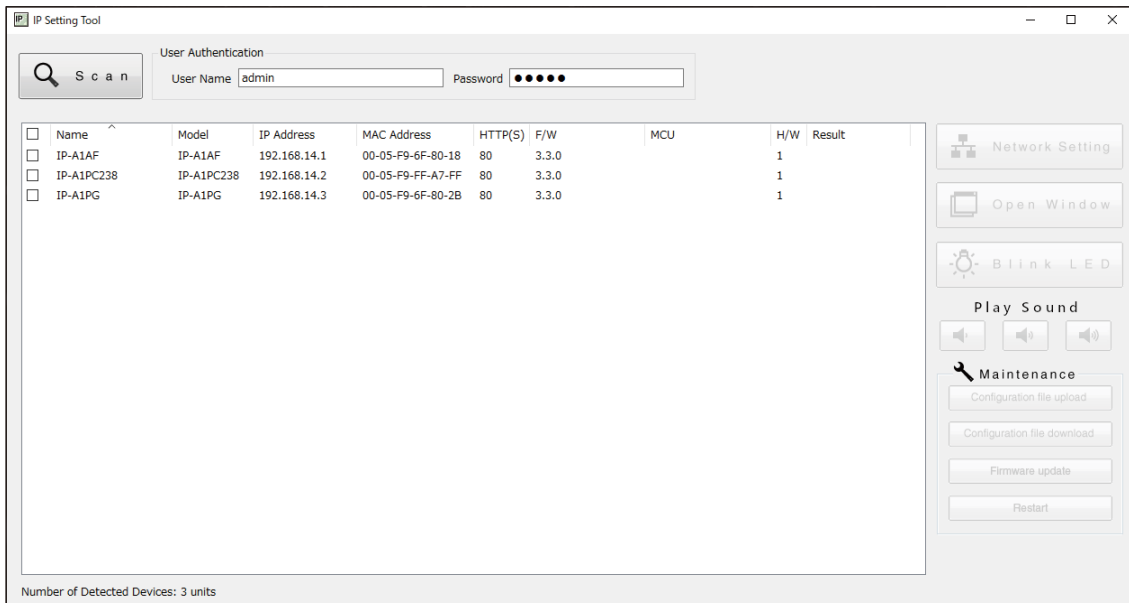

Selecting any device in the list by marking its corresponding checkbox activates its right-side button, thus making it possible to click on.

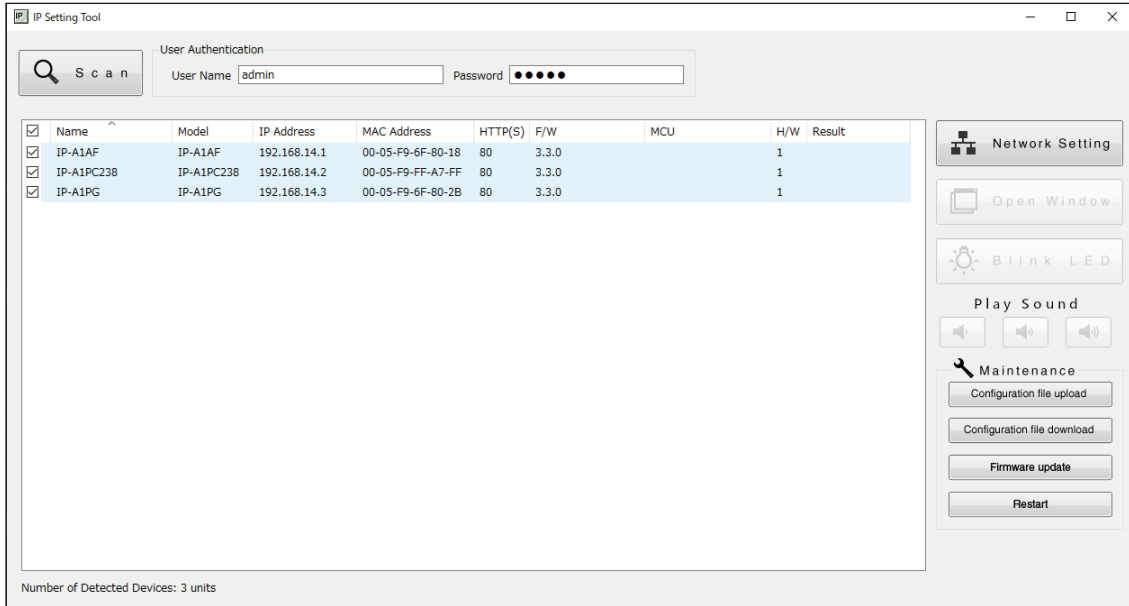

22.3. Setting Method

22.3.1. Display Contents

Notes

- Perform Items (4) and (11) after selecting the device by marking the checkbox in the Detection Results list.
- The operation results for Items (4), (6) to (11) are displayed in the Results field of the Detection Results list.
- Devices currently in Restart mode are not displayed.

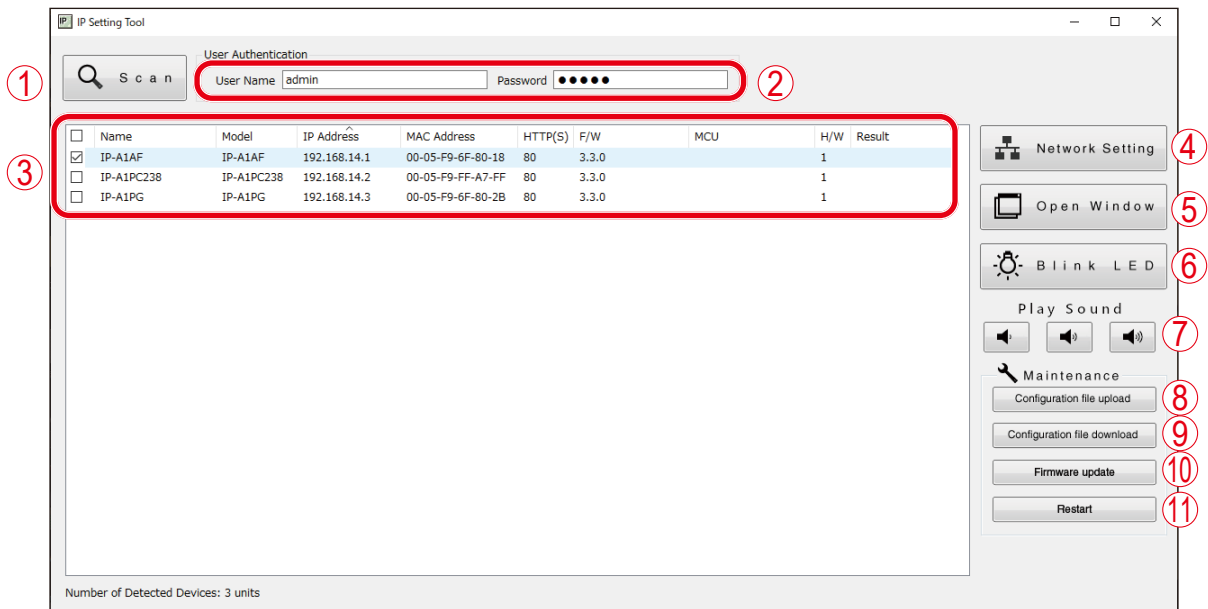

(1) Scan button

Click on this button to detect all IP Audio devices connected to the network. All connected devices are individually detected each time the button is clicked.

(2) Username and Password

Enter the username and password of the device to be operated. When the IP Setting Tool starts up, the device's default values (Username: admin; Password: guest) are entered.

(3) Detection Results list

Displays a list of detected devices.

(4) Network Setting button

Clicking on this button displays the Network Settings screen. (See "[Network Settings](#)" on p. 64.)

(5) Open Window button

Clicking on this button causes the browser to start up, displaying the Login screen for the selected device. (See "[CONNECTION WITH BROWSER](#)" on p. 10.)

(6) Blink LED button

When clicked, the status indicator for the selected device flashes 3 times.

(7) Play sound buttons (Only enabled when a receiving device is selected)

Clicking one of these buttons broadcasts a test sound from the selected device.

From left, these buttons can be used to broadcast at three different volume levels: low, medium and high.

(8) Configuration file upload button

Click on this button to upload the settings file from the PC. The same settings file can also be simultaneously uploaded to multiple devices. For details, please refer to "[Uploading Settings Files](#)" on p. 67.

(9) Configuration file download button

Click on this button to download the settings file to the PC. The downloaded settings file can be used as the original file when uploading the same settings file to multiple devices. For details, please refer to "[Downloading Settings Files](#)" on p. 68.

(10) Firmware Update button

Click on this button to update the device's firmware. The same firmware update can also be simultaneously carried out on multiple devices. For details, please refer to "[Firmware Update](#)" on p. 69.

(11) Restart button

Click on this button to restart the selected device(s).

22.4. User Authentication

Step 1. Enter the username and password.



Enter the username and password set for the detected device.

When setting up an unconfigured or initialized device, enter the following username and password:

Username: admin

Password: guest

Tip

To change the setting contents of the device(s) detected by the IP Setting Tool, the user authentication requirements of each device must be met.

Step 2. Click on the Scan button.

All detected devices are displayed on the Detection Results list, enabling the operation of buttons (4) to (10).

22.5. Network Settings

Perform all network settings, including the IP address, etc.

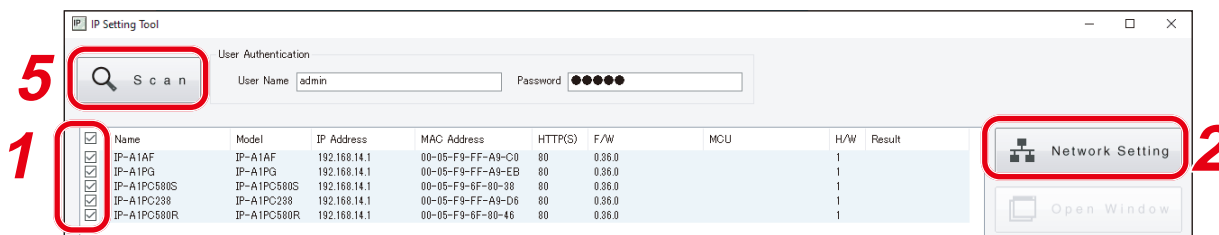

Step 1. Select the device(s) for which network settings will be performed by marking the corresponding checkbox in the Detection Results list.

Step 2. Click on the Network Setting button.

When only one device is selected, the Network settings screen for Single Setting is displayed.

When multiple devices are selected, the confirmation dialog box at right is displayed. Clicking on the OK button displays the Network settings screen for Multiple Setting.

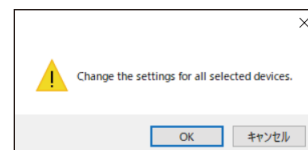

Step 3. Perform network settings.

Set the necessary items on the Single Setting or Multiple Setting screen.

[Network settings screen for Single Setting]

[Network settings screen for Multiple Setting]

	Item	Contents
A	Name	<p>Set the terminal name. Initial setting: (Product number)</p> <p>Note Names cannot be set in Multiple Setting. After all other Multiple Setting items have been set, go back and set only the name individually.</p> <p>Tips</p> <ul style="list-style-type: none"> • For usable characters, please refer to "USABLE CHARACTERS" on p. 59. • Max: 31 characters
B	IP Address Acquisition	<p>Set the method for acquiring the IP address. Initial setting: Manual</p> <p>Note The device is not compatible with DHCP. Always select Manual, and manually enter the device's network address.</p>
C	IP Address	<p>Set the device's IP address. In the case of Multiple Setting, since the IP addresses have consecutive numbers, these are automatically set for all devices. Therefore, enter the smallest numerical value in the left-side field. The IP address of the last consecutive number is displayed in the field at right. Initial setting: 192.168.14.1</p>
D	Subnet Mask	<p>Set the subnet mask. Initial setting: 255.255.255.0</p>
E	Default Gateway	<p>Set the default gateway. Initial setting: 0.0.0.0</p>
F	HTTP port	<p>Set the device's HTTP server port number. Usually, this port is used in its initial setting state. Setting range: 80 and 10000 – 40000 Initial setting: 80</p>

	Item	Contents
G	Confirm IP address conflict	<p>Mark the checkbox to confirm whether there are any conflicting IP addresses.</p> <p>Tips</p> <ul style="list-style-type: none"> • Even if the checkbox for the item "Confirm IP address conflict" is marked, certain conflicts related to network IP addresses that are different from the network adapter in use cannot be confirmed. • When an IP address conflict is detected, the indication "IP address conflict" appears in the display screen's Results field.
H	Set button	Click on this button to finalize the set contents.

Step 4. Click on the Set button.

This completes the network settings.

The Network settings screen closes and the device automatically restarts.

Step 5. Click on the Scan button.

The display screen is updated.

22.6. Uploading Settings Files

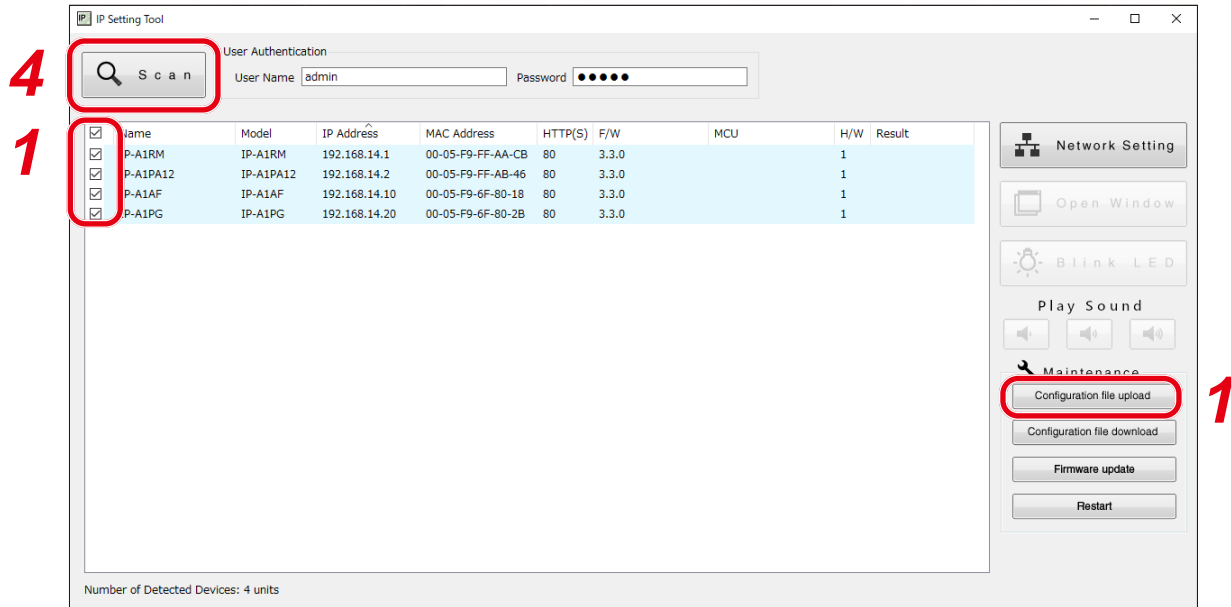

Note

Performing uploads during a broadcast will stop current broadcasts.

Step 1. Select the devices and click on the Configuration file upload button.

The file selection screen is displayed.

Step 2. Click on the Select button and select the settings file (extension ".spconf") to be uploaded.

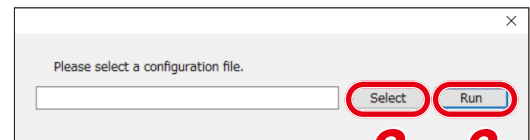

Step 3. Click on the Run button.

Settings file upload begins.

After upload is complete, the indication "OK" is displayed in the Results field, followed by automatic restart.

Step 4. Click on the Scan button.

The display screen is updated.

Notes

- Do not restart the device or turn off power during settings file upload.
- If the device is restarted or power is turned off during upload, the settings file could become corrupted, potentially making it impossible to start the device.
- Under circumstances in which the load on the network is high, the indication "No response" may be displayed in the Results field of the Detection Results list. In such cases, simply wait for a while. However, if the Result field is not updated, click on the Scan button again.
- When uploading the settings file, the sound source files are also copied to the device. The user and network settings are not applied to the device even if the settings file is uploaded, and their pre-upload states are maintained.

22.7. Downloading Settings Files

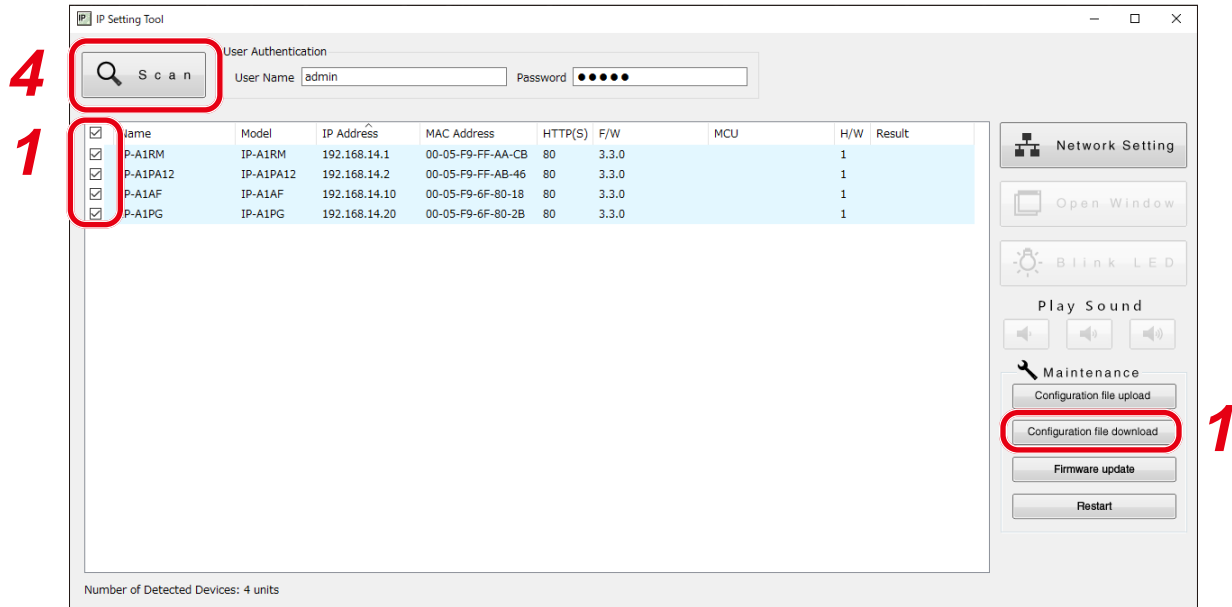

Step 1. Select the devices and click on the Configuration file download button.

The screen for selecting the download destination folder is displayed.

Step 2. Click on the Select button to select the download destination folder.

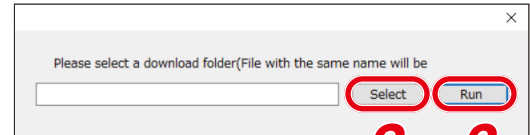

Step 3. Click on the Run button.

Settings file download begins.

After the download is completed, the OK indication appears in the Detection results list's Results field. The extension of the saved settings file is ".spconf."

Notes

- Do not restart the device or turn off power during settings file download. If the device is restarted or power is turned off during download, the settings file could become corrupted, potentially making it impossible to save the file.
- Downloading the settings file causes the setting data, including sound source files, to be downloaded. New network and user settings are not applied when the settings are restored or replicated by means of download and upload.

22.8. Firmware Update

Tip

Download the latest firmware after searching the TOADATA Library (<https://www.toa-products.com/international/>) for the product number.

Note

Do not change the filename of the downloaded firmware.

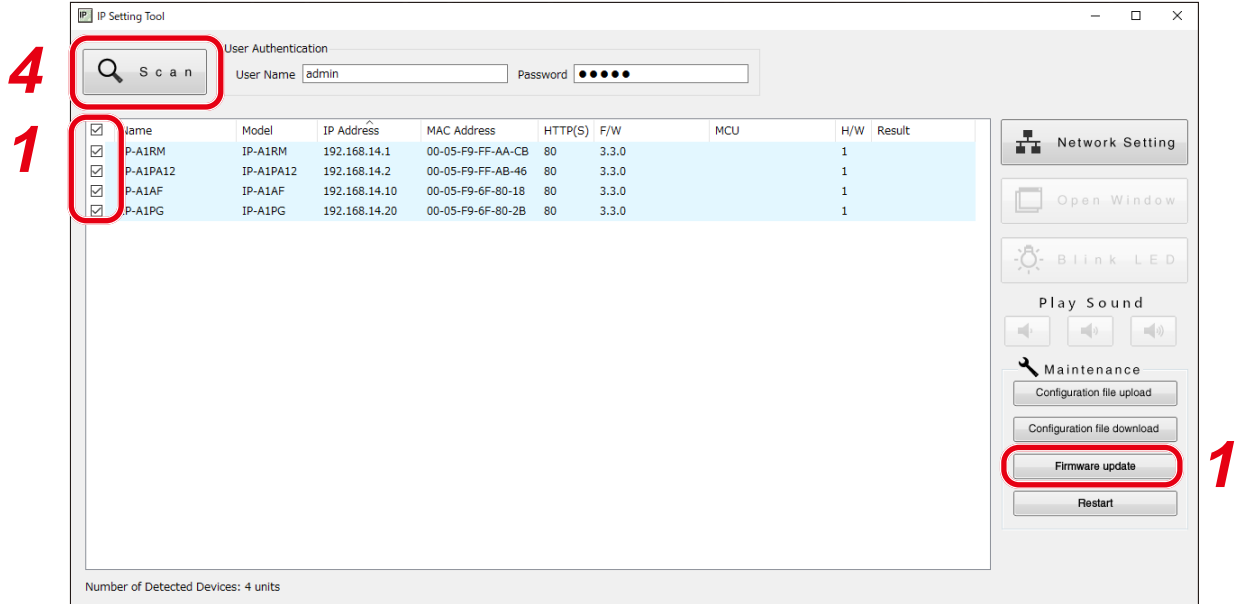

Step 1. Select the devices that will have its firmware updated, and click on the Firmware update button. The file selection screen is displayed.

Step 2. Click on the Select button to select the firmware file to be updated.

Tip

The firmware-updater's extension is ".bin."

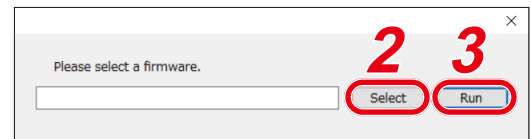

Step 3. Click on the Run button to begin the firmware update.

If the firmware update is complete after restart is finished, the OK indication is displayed in the Results field.

Step 4. Click on the Scan button. The display screen is updated.

Notes

- Do not restart the device or turn off power during firmware update. If the device is restarted or power is turned off during update, the firmware could become corrupted, potentially making it impossible to start the device.
- Under circumstances in which the load on the network is high, the indication "No response" may be displayed in the Results field of the display screen. In such cases, simply wait for a while. However, if the Result field is not updated, click on the Scan button again.

22.9. Restarting the Device

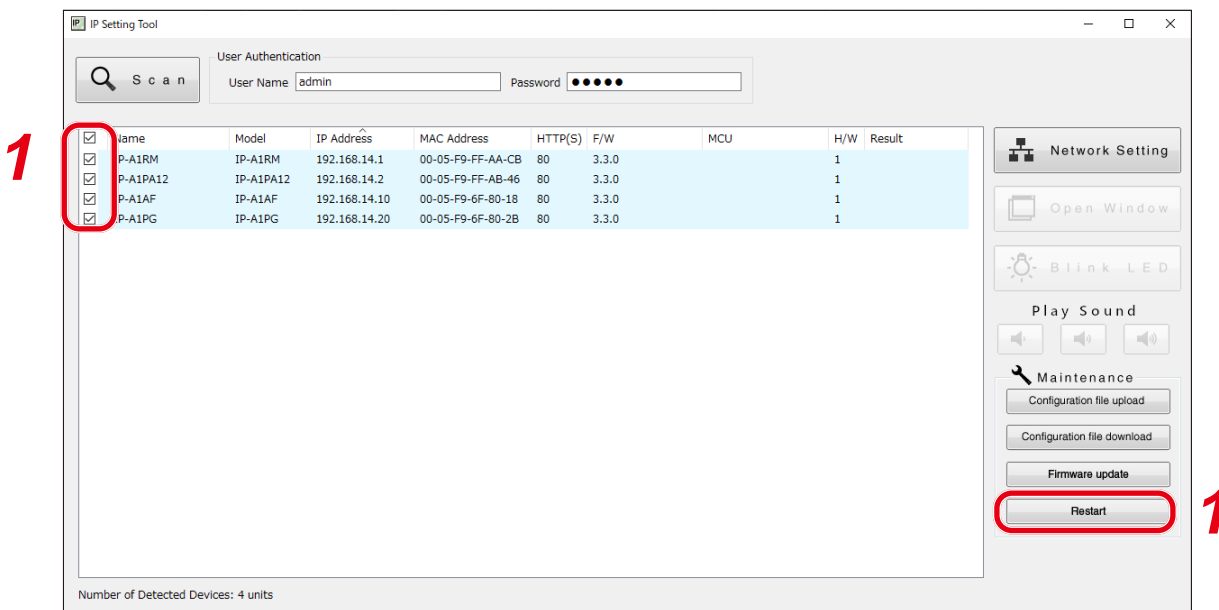

Step 1. Select the devices to be restarted and click on the Restart button.

The confirmation screen is displayed.

Tip

Multiple devices can also be selected for restart.

Step 2. Device restart begins when the OK button is clicked.

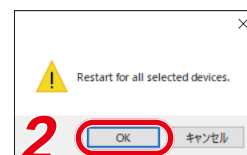

23. TROUBLESHOOTING

If a problem concerning the operation of this device is found, we recommend that you follow the procedure below to isolate the problem before requesting repair.

Step 1. Check the Power Supply.

		Check
Is power being supplied?	Is the Status indicator on the device lit or blinking? If it is off, power is not being supplied. Connect the device to a PoE switching hub to supply power.	
	Is the device connected to a PoE switching hub? This device operates on power supplied from a PoE switching hub. Make sure that the device is properly connected to a PoE switching hub that provides adequate power.	
	Does the connected equipment exceed the PoE switching hub's maximum power supply capacity? Check the PoE switching hub's instruction manual. If the total electrical load exceeds the capacity of the hub, replace it with a PoE hub that provides ample power supply capacity.	
Are there any LAN cable problems?	Is there a faulty contact connection due to a broken tab on the LAN connector? Poor contact between cable and connectors will interfere with both communications and power supply.	
	Is a Cat5* or higher grade LAN cable being used? Cables of a lower grade than Cat5* may interfere with power supply and communications. Change to a Cat5* or higher grade cable. * In case of IP-A1AF, IP-A1SC15, or IP-A1PA12: Cat5e	
	Are the pin layout and wiring of the RJ-45 LAN connector correct? If the pin layout or wiring is incorrect, communications and power supply may be impaired. Use the correct cable.	
	Is the LAN cable over 100m in length? If cable lengths exceed this limit, communications and power supply may be affected. Correct the wiring to ensure that all lengths are less than 100m by installing switching hubs wherever long lengths are found.	

Step 2. Check Network Communications.

		Check
Are network communications established?	Is the LINK/ACT indicator on the device lit or blinking? If it is not lit or blinking, network communications may not be fully established.	
	Can the device's IP address be accessed with a computer's browser to display the webpage Authentication screen? If the webpage Authentication screen cannot be displayed, network communications may not be established.	
	Does the device respond to a Ping command sent from the computer to its IP address? If there is no response, network communications may not be established.	
Is the webpage displayed correctly?	Is a compatible browser being used? Please access using Microsoft Edge or Google Chrome.	

		Check
Can the device be detected by the IP Setting Tool?	<p>Is the latest version of the IP Setting Tool being used? If an older version is being used, the device may not be correctly detected. Please download the latest version of the tool from the TOA DATA Library (https://www.toa-products.com/international/).</p>	
	<p>Are the device and the computer installed with the IP Setting Tool connected to the same network segment? If the network segments are different, the device may not be detected. Change the computer's IP address to that of the shared network segment.</p>	
	<p>Is the computer's firewall or antivirus software enabled? The influence of a firewall or antivirus software may cause the device to not be detected. Temporarily disable these security functions.</p>	

Step 3. Check the Operating Status and Settings.

		Check
Does the Status indicator switch to broadcasting status?	<p>[IP-A1AF, IP-A1PC580R, IP-A1PC580S] When a broadcast begins, the Status indicator should light up in blue. If the Status indicator does not change, even after starting the broadcast, it may be possible that the status setting has not changed to Broadcast status.</p> <p>[IP-A1PC238, IP-A1SC15] The Status indicator should light up in both Broadcast and Broadcast Standby modes. Therefore, the current operating status cannot be determined from the Status indicator alone. Check the operating status on the webpage Status screen.</p>	
Is System Mute enabled?	<p>[IP-A1AF, IP-A1PC580R, IP-A1PC580S] If the Status indicator is flashing red, the system is currently muted. If, for any reason, the system mute is controlled by the transmitting device, check the status of the transmitting device.</p> <p>[IP-A1PC238, IP-A1SC15] If the Status indicator is flashing quickly, the system is currently muted. If, for any reason, the system mute is controlled by the transmitting device, check the status of the transmitting device.</p> <p>[IP-A1PA12] If the Status indicator is flashing red, the system is currently muted. The system mute is enabled by either the system mute control being applied by a transmitting device or a 24 V DC cut-off signal input to the mute terminal. Check the status of the transmitting device or the receiving device's mute input terminal connection. If, for any reason, the system mute is controlled by the transmitting device, check the status of the transmitting device.</p>	
PA12 Is the external amplifier enabled?	<p>If the status indicator flashes green or blue after the IP Receiver is started, this indicates that the external amplifier is enabled and the internal amplifier is disconnected from the speaker output.</p>	
Does the Status item change on the webpage Status screen?	<p>When shifting to Broadcast status, the Status item changes from the Idle display to the display showing the status of each broadcast in conjunction with the broadcast start operation. If the display does not show the broadcast status, it's possible that the broadcast start operation has not been accepted.</p>	
[SIP Broadcasting] Is the SIP Registration Status set to "Registered"?	<p>In order to perform SIP broadcasting via the SIP server, the device must be registered on the SIP server. If the device has not been registered, check the following settings on the SIP Settings screen.</p> <ul style="list-style-type: none"> • Is SIP Account Active turned ON? • Is the SIP Server Address/Port setting correct? • Are the User ID, Password, and Authentication ID settings correct? 	

		Check
[VMS Broadcasting] Can a VMS server/client or network recorder be used to detect/connect to the device?	To perform VMS broadcasting, it is necessary to detect/connect the device with the broadcasting source or its software. If the device cannot be detected/connected to, check the following settings on the VMS Broadcasting Settings screen. <ul style="list-style-type: none"> • Is VMS Connection turned ON? • Are the Control Port settings for both the device and the broadcasting source the same? • Is the RTSP Port set to an appropriate value according to the network environment? (If connected via LAN, there is no need to change the initial settings.) • Are the Username and Password settings correct? 	
[Multicast Broadcasting] Do the settings of the multicast channel used by the sending and receiving terminals match?	For Multicast broadcasting, the multicast channel settings located in the "Destination" setting of the transmitting device and the "Multicast" settings of the receiving device must match. Check the following settings: <ul style="list-style-type: none"> • Is Multicast Function turned ON? • Do the multicast address and the port numbers of the transmitting and receiving devices all match? • Are even numbers being used for the port numbers? • Are all the multicast channels set to "Enable"? 	
[Local Broadcasting] Is the Local Broadcasting Settings turned ON?	To perform local broadcasting, turn Local Broadcasting ON. If OFF, the audio input will be directed toward the network, so no audio will be output from the local speaker.	
Do the audio codecs enabled at the transmitting and receiving devices match?	If the audio codec selected at the transmitting device is disabled at the receiving device, data transmissions cannot be decoded and played back via the receiving device. Opus has been added to the audio codec in firmware versions 3.1.0 or later, and made the default setting. Be sure that the firmware of the receiving device is also updated to Ver. 3.1.0 or later, or set the audio codec of the transmitting device to match that of the receiving device.	



Step 4. Check the Event Trigger.

		Check
Is a control signal being input?	Is the control signal being input to the control input terminal? Input a no-voltage signal. Since the device can be either Normally Open or Normally Closed, both make and break contacts are supported. Also, because the device is compatible with both Edge and Level detections, these can be set on the Signal Mode line of the Event Settings screen's Control-In settings.	
Is the control signal input long enough (in ms)?	The minimum duration for the control input to initiate a short is 200ms. Be sure that the signal is input for at least 200ms.	

		Check
Are the Event settings correctly set?	<p>Is Action correctly set on the Event Settings screen's Control-In settings? When a control signal is received at the control input terminal, the operation selected in Action will be enabled.</p> <ul style="list-style-type: none"> • Pattern 1 – 20: Plays/Stops the internal sound source selected in the Pattern settings. (Note that this is not applicable to Timer-specified patterns.) • SIP 1, 2: Initiates a SIP call to the SIP phone set for SIP 1 and SIP 2. • Local Broadcasting: Starts/Stops Local broadcasting. • Offset Volume: Temporarily offsets the speaker volume by the set volume. • Speaker Mute: Temporarily mutes the speaker volume. <p>PA12</p> <ul style="list-style-type: none"> • External Amplifier: The external amplifier signal input is output through the speaker output terminals. 	
Is the correct remote API command being transmitted?	<p>Check that the URI of the transmitted command is correct. Check for the correct command based on the Remote API Specifications. For more information on Remote API Specifications, please contact your nearest TOA subsidiary.</p>	
When using Remote API, has Digest Authentication been performed in advance?	<p>In order to control commands by Remote API, Digest Authentication by way of ID & Password is first required. Since commands will only be accepted after Authentication is complete, first check for completed Authentication.</p>	
Was the device restarted after changing its setting?	<p>When the device's settings are changed, some items require a restart before the changed contents are reflected. (See p. 17.)</p>	

Step 5. Check the Sound.

		Check
Is the device's gain appropriately set for the equipment connected to the LINE/MIC IN terminals?	<p>Set the device's gain with the DIP switch, depending on the type of equipment connected to the LINE/MIC IN terminals.</p> <ul style="list-style-type: none"> • Line output equipment: LINE / [PAD] 0 dB / [PHANTOM] OFF • Dynamic microphone: MIC / [PAD] 0 dB / [PHANTOM] OFF • Condenser microphone: MIC / [PAD] –20 dB / [PHANTOM] ON <p>Also, make sure that the output level of the connected equipment is correctly set.</p>	
PA12 Are the speakers to be used connected to the terminals that match their specifications?	<p>Three speaker outputs are available: 25 V, 70 V and 100 V lines for high-impedance speakers. Check the specifications of the speakers to be used, and connect to the appropriate terminals. Use the 25 V/70 V selector switch on the rear panel to switch between high-impedance 25 V and 70 V lines.</p>	
Is the LINE/MIC input volume control turned fully counter-clockwise?	<p>Audio input volume can be adjusted using the LINE/MIC input volume control. Adjust the input sound volume while monitoring the LINE/MIC signal indicator so that it remains constantly lit green and only rarely lights red.</p>	
Is the Speaker Volume set correctly? Is the Mute enabled?	<p>The speaker's output volume is controlled by the Speaker Volume. Speaker Volume can be checked on the Status screen, where the current volume or Mute status is also displayed. The Speaker Volume is determined by the sum of the Master Volume and the Offset Volume set on the Audio Settings screen. The Offset Volume can be changed by an event, by a contact input, or by Remote API external control.</p>	

		Check
[SIP Broadcasting] Is the SIP phone (or SIP terminal) set to the correct volume?	If the source SIP phone (or SIP device) sound output seems too quiet or too loud, the speaker output may not be set to the correct volume and sound quality. If sound output is too quiet, it may be adjusted using the Audio Settings screen's Input Volume (SIP) setting. If it is too loud and sounds like it's breaking up, turn down the volume of the SIP phone (or SIP device).	
   [SIP Conversations] Is the volume of the other party heard on the SIP phone (or SIP device) correct?	If the volume of the other party is not correct, check the following items: <ul style="list-style-type: none"> • Is the equipment connected to the LINE/MIC IN terminal set to the correct output volume? • Is the gain setting for the device's LINE/MIC IN terminal correct? (Check the DIP switch.) • Is the LINE/MIC IN volume control set to the correct volume? • Adjust LINE/MIC IN Sensitivity on the Audio Settings screen. 	
[VMS Broadcasting] Is the volume of the microphone connected to the VMS server/client or network recorder correct?	If the volume of the sound transmitted by the source VMS server/client or network recorder is too quiet or too loud, the speaker output may not have the appropriate volume or sound quality. If too quiet, this may be corrected by adjusting the Input Volume (VMS Broadcasting) on the Audio Settings screen. If it is too loud and breaking up, turn down the volume of the source microphone.	
[Multicast Broadcasting] Is the volume of each multicast channel correct?	In Multicast broadcasting, the volume of each multicast channel used can be set for each receiving terminal. By adjusting the Audio Settings screen's Input Volume (Multicast 1 – 20), the appropriate volume can be set for each multicast channel.	
[Internal Sound Source Broadcasting] Can sound source files be uploaded to the Media Settings screen?	There may be some restrictions on the sound sources that can be uploaded to the Media Settings screen. Please check to see if any of these restrictions are applicable and try uploading again. <ul style="list-style-type: none"> • Only WAV and MP3 sound source files can be uploaded. • The usable file formats for both WAV and MP3 are fixed. Before use, please check the details (see p. 33). • Sound source files of over 30 MB in size cannot be uploaded. (see p. 33.) • Total Media file size cannot exceed 80 MB. (see p. 33.) • Does the filename contain spaces or characters/symbols that cannot be used? (see p. 60.) 	
[Internal Sound Source Broadcasting] Is the sound file being played using PLAY button on the Pattern Registration screen set to an appropriate volume?	Clicking PLAY button on the Pattern registration screen allows the sound source to be played from the device's speaker, LINE output, or monitor output under the preset pattern conditions, thus making it possible to confirm that the sound source and volume are appropriate. If the volume is not appropriate, check that the sound source itself is not cracked, that the "Input Volume" set in the pattern is not too loud, and that the "Master Volume" is not too loud.	
[Local Broadcasting] Is the local broadcasting volume set correctly?	If the Local broadcasting volume is not correct, check the following items: <ul style="list-style-type: none"> • Is the equipment connected to the LINE/MIC IN terminal set to the correct output volume? • Is the gain setting for the device's LINE/MIC IN terminal correct? (Check the DIP switch.) • Is the LINE/MIC IN volume control set to the correct volume? • Adjust the Input volume on the Local Broadcasting Settings screen. 	

24. WHAT TO DO WHEN IN TROUBLE

IP address unknown.	If the IP address of the device is unknown, use either of the following procedures to connect: 1. Detect the device with the IP setting tool. 2. Initialize the system settings with the reset key, and reconnect using the default IP address.
Login ID/Password unknown.	If the login ID/password for this device are unknown, the system can be logged into with the default login ID/password by reinitializing the system with the reset key. Note All settings will also be initialized, so be sure that the current settings are downloaded and saved in advance.
Locating a specific device among multiple receiving devices.	Use either of the following procedures to locate a specific receiving device among multiple devices: 1. Use the IP Setting Tool's Play Sound function. 2. Use the IP Setting Tool's Blink LED function.